

Parallel grippers HGPT-B, heavy-duty

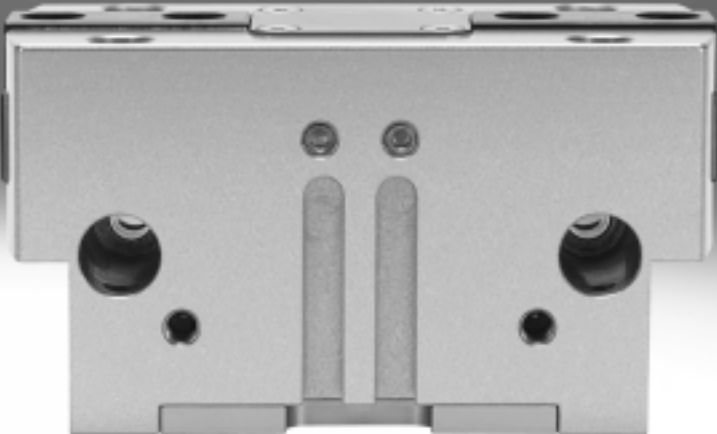

Parallel grippers HGPT-B, heavy-duty

Key features

Advantages compared with the parallel gripper HGPT

- Space-optimised:**
 Choice of shorter housing without gripping force retention or longer housing with gripping force retention
- Increased gripping force/high-force variant:**
 Gripping force increased by 30% by means of oval piston. High-force variant also available: half the stroke, twice the force
- Reduced weight:**
 Systematic use of lighter and higher performance materials
- 4 sensor slots:**
 Proximity sensors no longer project past the bottom of the housing. Up to four positions can be sensed with the proximity sensors

At a glance

General information

Sturdy and precise kinematic system for maximum torque absorption and long service life. The force generated by the linear motion is translated into the gripper jaw movement via a wedge mechanism

with guided motion sequence. This also guarantees synchronous movement of the gripper jaws. The virtually backlash-free plain-bearing guide is realised using ground-in gripper jaws.

Flexible range of applications

A wide range of uses:

- Can be used as either a double-acting or single-acting gripper
- Compression spring for supplementary or retaining gripping forces
- Suitable for external and internal gripping
- Centring either via centring pins or centring sleeves

The technology in detail

Gripper closed

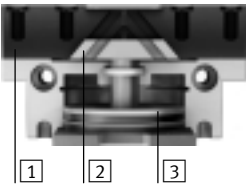

Gripper open



- Gripper jaw
- Wedge with restricted guidance
- Piston with magnet

Additional connections

For sealing air

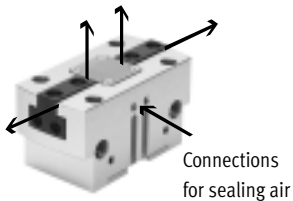

Compressed air flows past the gripper jaw when sealing air (max. 0.5 bar) is connected. This prevents, for example, dust particles from entering the gripper jaw guides.

For lubrication



The connections can also be used for relubricating the guide.

Position sensing/force control

With position transmitter SMAT-8M



Analogue positional feedback possible

- Analogue output 0 ... 10 V

With proportional pressure regulator VPPM



Infinite adjustment of the gripping force possible

- Setpoint input
 - 0 ... 10 V
 - 4 ... 20 mA

With proximity sensor SMT-8G/-10G



Multiple positions can be sensed:

- Open
- Closed
- Workpiece gripped

Parallel grippers HGPT-B, heavy-duty

Key features

Wide range of supply ports

Direct
From the front

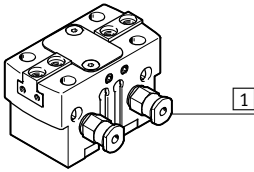

Via adapter plate
From underneath

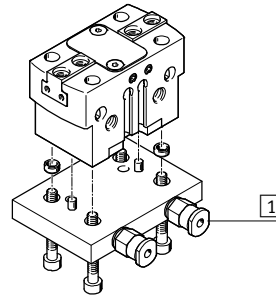

1 Supply ports

Mounting options

Direct mounting
From above

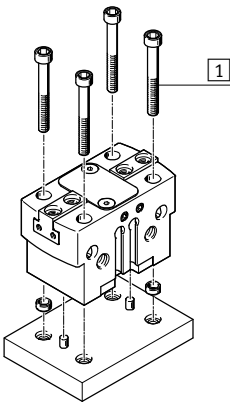

From underneath or from the side

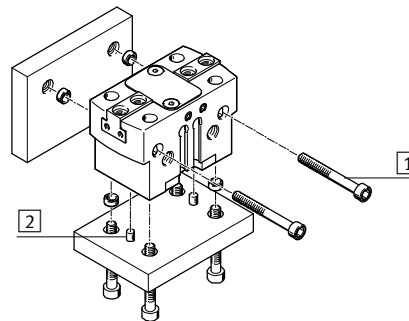

1 Mounting screws
2 Centring pins, centring sleeves

Note

These grippers are not suitable or are of limited suitability for the following application examples:

Not suitable for:

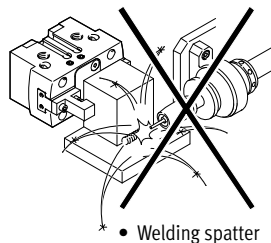

- Welding spatter

Of limited suitability for:

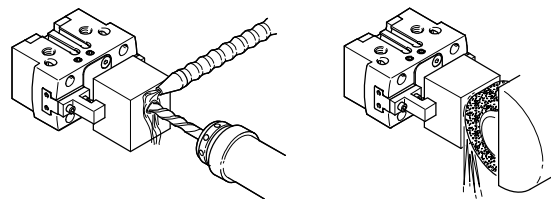

- Machining with sealing air possible
- Aggressive media only possible after consultation with Festo

Parallel grippers HGPT-B, heavy-duty

Key features

FESTO

System product for handling and assembly technology

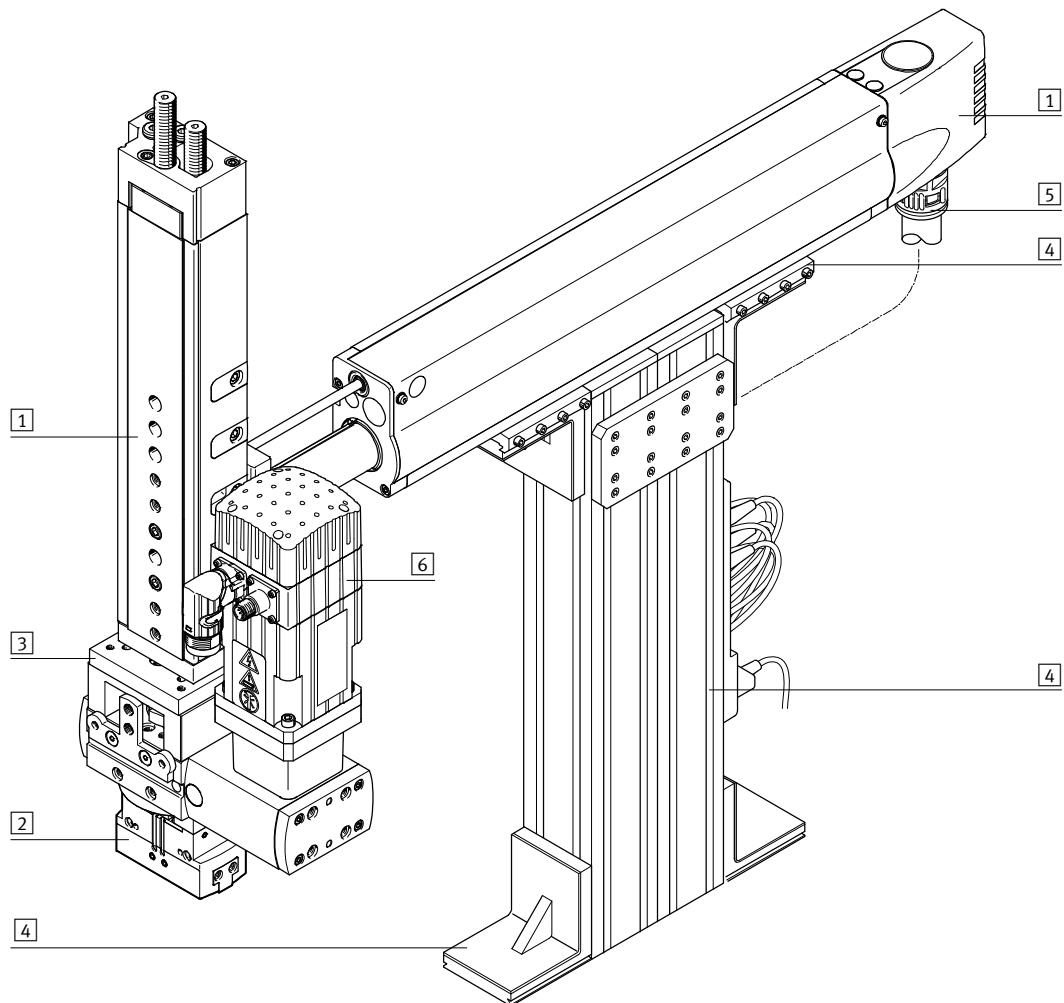

| System components and accessories | | |
|-----------------------------------|-------------------------|--|
| | Brief description | → Page/Internet |
| 1 | Drives | Wide range of combinations possible within handling and assembly technology drive |
| 2 | Grippers | Wide range of variations possible within handling and assembly technology gripper |
| 3 | Adapters | For drive/drive and drive/gripper connections adapter kit |
| 4 | Basic components | Profiles and profile connections as well as profile/drive connections basic component |
| 5 | Installation components | For a clear, safe layout of electrical cables and tubing installation component |
| 6 | Motors | Servo and stepper motors, with or without gearing motor |
| - | Axes | Wide range of combinations possible within handling and assembly technology axis |

Parallel grippers HGPT-B, heavy-duty

Peripherals overview

FESTO

Peripherals overview

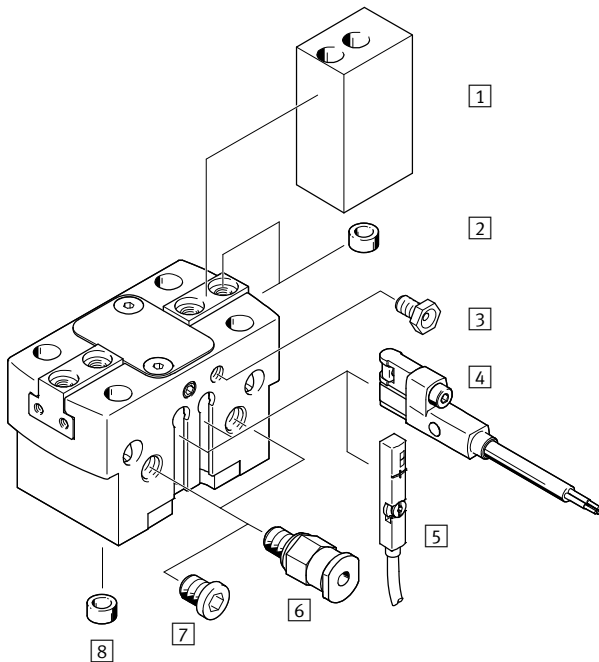

System product for handling and assembly technology

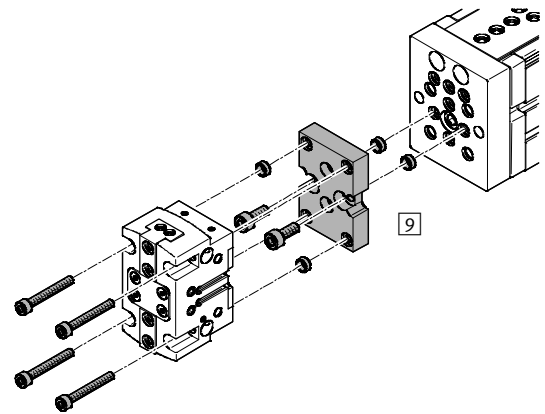

Proportional pressure regulator VPPM

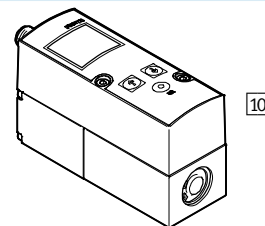

| Accessories | | | |
|-------------|---|--|------------|
| Type | Brief description | → Page/Internet | |
| 1 | Gripper jaw blank BUB-HGPT | Blank specially matched to the gripper jaws for custom production of gripper fingers | 22 |
| 2 | Centring sleeve ZBH | <ul style="list-style-type: none"> For centring gripper jaw blanks/gripper fingers on the gripper jaws Centring sleeves are included in the scope of delivery of the gripper | 23 |
| 3 | Lubrication nipple | Included in the scope of delivery of the gripper | – |
| 4 | Proximity sensor SMT-8G/-10G | <ul style="list-style-type: none"> For sensing the piston position The proximity sensor is flush with the housing at the bottom | 24 |
| 5 | Position transmitter SMAT-8M | <ul style="list-style-type: none"> Continuously senses the position of the piston. It has an analogue output with an output signal that is proportional to the piston position. For size 40 ... 80 | 24 |
| 6 | Push-in fitting QS | For connecting compressed air tubing with standard O.D. | quick star |
| 7 | Blanking plug B | For sealing the supply ports when using the lower supply ports | 23 |
| 8 | Centring sleeve ZBH | For centring the gripper during mounting | 23 |
| 9 | Adapter kit DHAA, HMSV, HAPG | Drive/gripper connections | 19 |
| 10 | Proportional pressure regulator VPPM | For infinite adjustment of the gripping force | vppm |

Parallel grippers HGPT-B, heavy-duty

Type codes

HGPT – 16 – A – B – F –

| Type | |
|--------------------------|----------------------|
| HGPT | Parallel gripper |
| Size | |
| | |
| Position sensing | |
| A | Via proximity sensor |
| Variant | |
| B | B series |
| Force variant | |
| F | High force |
| Gripping force retention | |
| G1 | Opening |
| G2 | Closing |

Parallel grippers HGPT-B, heavy-duty

Technical data

Function
Double-acting
HGPT-...

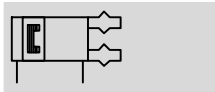

⌀ - Size
16 ... 80 mm

— Total stroke
3 ... 50 mm

Function – Variants
Single-acting or
with gripping force retention ...

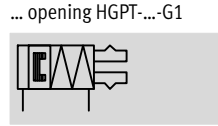

... opening HGPT-...-G1



... closing HGPT-...-G2



| General technical data | | | | | | | | | | |
|---|-------------------|--|-------|--------|-----|-----|------|-------|-------|--|
| Size | | 16 | 20 | 25 | 35 | 40 | 50 | 63 | 80 | |
| Design | | Wedge mechanism Guided motion sequence | | | | | | | | |
| Mode of operation | | Double-acting | | | | | | | | |
| Gripper function | | Parallel | | | | | | | | |
| Number of gripper jaws | | 2 | | | | | | | | |
| Max. load per external gripper finger ¹⁾ | [g] | 40 | 50 | 110 | 180 | 310 | 640 | 1,260 | 1,830 | |
| Stroke per gripper jaw | HGPT-...-A [mm] | 3 | 4 | 6 | 8 | 10 | 12 | 16 | 25 | |
| | HGPT-...-A-F [mm] | 1.5 | 2 | 3 | 4 | 5 | 6 | 8 | 12.5 | |
| Pneumatic connection | | M5 | M5 | M5 | M5 | M5 | G1/8 | G1/8 | G1/4 | |
| Pneumatic connection, sealing air | | M3 | M3 | M5 | M5 | M5 | M5 | M5 | M5 | |
| Repetition accuracy ²⁾ | [mm] | ±0.01 | ±0.02 | ±0.025 | | | | | | |
| Max. interchangeability | [mm] | 0.2 | | | | | | | | |
| Max. operating frequency | [Hz] | 3 | | | | 2 | | | | |
| Rotational symmetry | [mm] | < Ø 0.2 | | | | | | | | |
| Position sensing | | Via proximity sensor, position transmitter | | | | | | | | |
| Type of mounting | | Via through-hole and locating pin/centring sleeve | | | | | | | | |
| | | Via female thread and locating pin/centring sleeve | | | | | | | | |
| Mounting position | | Any | | | | | | | | |

1) Valid for unthrottled operation

2) End-position drift under constant conditions of use with 100 consecutive strokes in the direction of movement of the gripper jaws

— Note: This product conforms to ISO 1179-1 and to ISO 228-1

| Operating and environmental conditions | | | |
|--|--------------------|--|--|
| Min. operating pressure | HGPT-...-A [bar] | 3 | |
| | HGPT-...-A-G [bar] | 4 | |
| Max. operating pressure | [bar] | 8 | |
| Operating pressure, sealing air | [bar] | 0 ... 0.5 | |
| Operating medium | | Compressed air in accordance with ISO 8573-1:2010 [7:4:4] | |
| Note on operating/pilot medium | | Operation with lubricated medium possible (in which case lubricated operation will always be required) | |
| Ambient temperature ¹⁾ | [°C] | +5 ... +60 | |
| Corrosion resistance class CRC ²⁾ | | 2 | |

1) Note operating range of proximity sensors.

2) Corrosion resistance class 2 according to Festo standard 940 070

Components subject to moderate corrosion stress. Externally visible parts with primarily decorative surface requirements which are in direct contact with a normal industrial environment or media such as coolants or lubricating agents.

Parallel grippers HGPT-B, heavy-duty

Technical data

| Weight [g] | | | | | | | | |
|--------------|-----|-----|-----|-----|-------|-------|-------|-------|
| Size | 16 | 20 | 25 | 35 | 40 | 50 | 63 | 80 |
| HGPT-...-A | 85 | 135 | 266 | 490 | 821 | 1,400 | 2,712 | 4,745 |
| HGPT-...-A-F | 85 | 135 | 266 | 490 | 821 | 1,400 | 2,712 | 4,745 |
| HGPT-...-A-G | 100 | 155 | 353 | 567 | 1,075 | 1,832 | 3,562 | 6,287 |

Materials

Sectional view

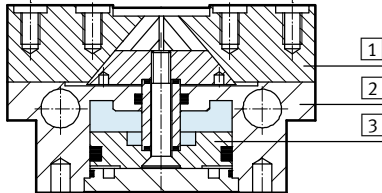

| Parallel gripper | | |
|------------------|-------------------|---|
| 1 | Gripper jaw | Hardened steel |
| 2 | Housing | Hard anodised wrought aluminium alloy |
| 3 | Piston | Hard anodised aluminium |
| - | Seals | Nitrile rubber |
| - | Note on materials | Free of copper, PTFE and silicone RoHS-compliant |

Gripping force [N] at 6 bar

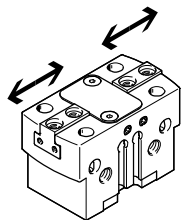

| Size | | 16 | 20 | 25 | 35 | 40 | 50 | 63 | 80 |
|--------------------------------|---------|-----|-----|-----|-------|-------|-------|-------|-------|
| Gripping force per gripper jaw | | | | | | | | | |
| HGPT-...-A | Opening | 60 | 82 | 133 | 245 | 355 | 570 | 896 | 1,613 |
| | Closing | 53 | 77 | 124 | 229 | 331 | 535 | 851 | 1,551 |
| HGPT-...-A-F | Opening | 108 | 172 | 238 | 500 | 723 | 1,185 | 1,885 | 3,275 |
| | Closing | 96 | 161 | 221 | 467 | 674 | 1,113 | 1,791 | 3,150 |
| Total gripping force | | | | | | | | | |
| HGPT-...-A | Opening | 120 | 162 | 266 | 490 | 710 | 1,140 | 1,792 | 3,226 |
| | Closing | 106 | 154 | 248 | 458 | 662 | 1,070 | 1,702 | 3,102 |
| HGPT-...-A-F | Opening | 216 | 344 | 476 | 1,000 | 1,446 | 2,370 | 3,770 | 6,550 |
| | Closing | 192 | 322 | 442 | 934 | 1,328 | 2,226 | 3,522 | 6,300 |

Parallel grippers HGPT-B, heavy-duty

Technical data

Characteristic load values at the gripper jaws

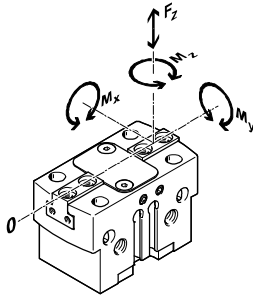

The indicated permissible forces and torques apply to a single gripper jaw. They include the lever arm, additional applied loads due to the workpiece or gripper fingers and acceleration

forces occurring during movement. The zero co-ordinate line (gripper jaw guide) must be taken into consideration for the calculation of torques.

| Size | | 16 | 20 | 25 | 35 | 40 | 50 | 63 | 80 |
|-------------------------------|------|-----|-----|-------|-------|-------|-------|-------|-------|
| Max. permissible force F_z | [N] | 200 | 700 | 1,200 | 1,800 | 2,500 | 3,200 | 5,000 | 7,000 |
| Max. permissible torque M_x | [Nm] | 10 | 15 | 50 | 80 | 100 | 120 | 160 | 180 |
| Max. permissible torque M_y | [Nm] | 12 | 15 | 45 | 60 | 90 | 120 | 180 | 220 |
| Max. permissible torque M_z | [Nm] | 6 | 8 | 35 | 50 | 75 | 100 | 140 | 170 |

Mass moment of inertia [$\text{kgm}^2 \times 10^{-4}$]

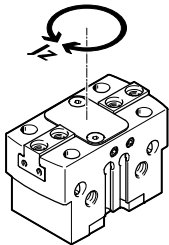

Mass moment of inertia of the parallel gripper in relation to the central axis, without external gripper fingers, without load.

| Size | | 16 | 20 | 25 | 35 | 40 | 50 | 63 | 80 |
|--------------|--|-------|-------|-------|-------|--------|--------|--------|---------|
| HGPT-...-A | | 0.141 | 0.344 | 0.983 | 2.807 | 7.277 | 19.488 | 60.903 | 150.515 |
| HGPT-...-A-G | | 0.163 | 0.445 | 1.479 | 3.974 | 10.990 | 29.423 | 93.034 | 238.336 |

Gripper jaw backlash

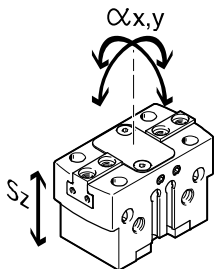

With grippers, backlash occurs between the gripper jaws and the housing due to the plain-bearing guide. The backlash values listed in the table have been calculated based on the traditional accumulative tolerance method.

| Size | | 16 | 20 | 25 | 35 | 40 | 50 | 63 | 80 |
|--|------|------|----|----|----|----|----|----|----|
| Max. gripper jaw backlash S_z | [mm] | 0.02 | | | | | | | |
| Max. gripper jaw angular backlash α_x, α_y | [°] | 0.1 | | | | | | | |

Parallel grippers HGPT-B, heavy-duty

Technical data



Opening and closing times [ms] at 6 bar

Without external gripper fingers

With external gripper fingers

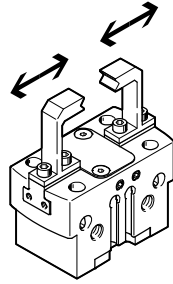
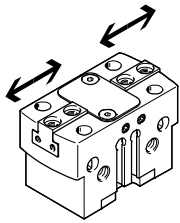

The indicated opening and closing times [ms] have been measured at room temperature at an operating pressure of 6 bar with horizontally mounted gripper without additional

gripper fingers. The grippers must be throttled for greater loads [g]. Opening and closing times must then be adjusted accordingly.

| Size | | | 16 | 20 | 25 | 35 | 40 | 50 | 63 | 80 |
|---|-----------------|---------|----|----|----|-----|-----|-----|-----|-----|
| Without external gripper fingers | | | | | | | | | | |
| Standard | HGPT-...-A | Opening | 9 | 22 | 26 | 36 | 56 | 80 | 150 | 214 |
| | | Closing | 11 | 30 | 32 | 67 | 60 | 85 | 156 | 213 |
| | HGPT-...-A-G1 | Opening | 13 | 13 | 24 | 37 | 67 | 70 | 146 | 182 |
| | | Closing | 31 | 25 | 48 | 114 | 135 | 153 | 328 | 353 |
| | HGPT-...-A-G2 | Opening | 22 | 35 | 40 | 69 | 122 | 151 | 294 | 379 |
| | | Closing | 15 | 18 | 28 | 87 | 71 | 77 | 185 | 176 |
| High force | HGPT-...-A-F | Opening | 8 | 28 | 25 | 33 | 60 | 83 | 143 | 212 |
| | | Closing | 10 | 31 | 32 | 70 | 64 | 82 | 152 | 211 |
| | HGPT-...-A-F-G1 | Opening | 19 | 13 | 24 | 35 | 71 | 70 | 145 | 180 |
| | | Closing | 30 | 25 | 45 | 115 | 143 | 143 | 315 | 340 |
| | HGPT-...-A-F-G2 | Opening | 33 | 38 | 36 | 63 | 120 | 137 | 308 | 362 |
| | | Closing | 17 | 14 | 28 | 72 | 72 | 80 | 154 | 178 |
| With external gripper fingers (as a function of the load) | | | | | | | | | | |
| HGPT-... | 50 g | 10 | - | - | - | - | - | - | - | - |
| | 100 g | 15 | 30 | - | - | - | - | - | - | - |
| | 200 g | 21 | 42 | 35 | - | - | - | - | - | - |
| | 300 g | - | 52 | 42 | 42 | - | - | - | - | - |
| | 400 g | - | - | 49 | 49 | 63 | - | - | - | - |
| | 500 g | - | - | - | 55 | 71 | - | - | - | - |
| | 600 g | - | - | - | - | 78 | - | - | - | - |
| | 800 g | - | - | - | - | 90 | 90 | - | - | - |
| | 1,000 g | - | - | - | - | - | 95 | - | - | - |
| | 1,200 g | - | - | - | - | - | 100 | - | - | - |
| | 1,500 g | - | - | - | - | - | - | - | 164 | - |
| | 1,800 g | - | - | - | - | - | - | - | 179 | - |
| | 2,000 g | - | - | - | - | - | - | - | 189 | 223 |
| | 2,200 g | - | - | - | - | - | - | - | - | 234 |
| 2,400 g | - | - | - | - | - | - | - | - | 244 | |

Parallel grippers HGPT-B, heavy-duty

Technical data

Gripping force F_H per gripper jaw as a function of operating pressure and lever arm x

The gripping forces as a function of operating pressure and lever arm can be determined from the following graphs.

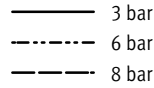
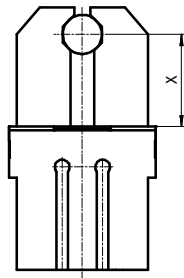

Note
Gripper selection
sizing software
→ www.festo.com

External gripping (closing)

Standard

HGPT-16-A

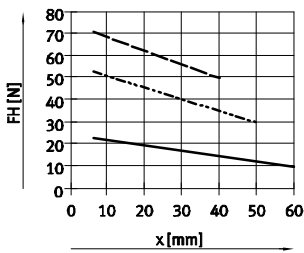

HGPT-20-A

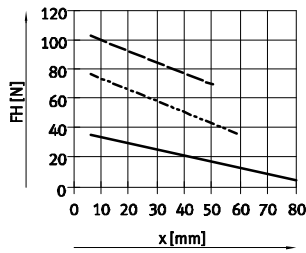

HGPT-25-A

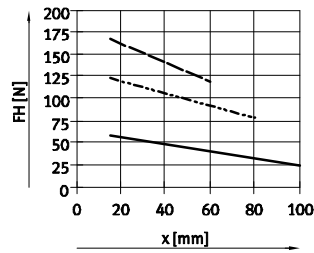

HGPT-35-A

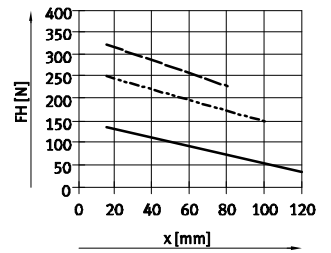

HGPT-40-A

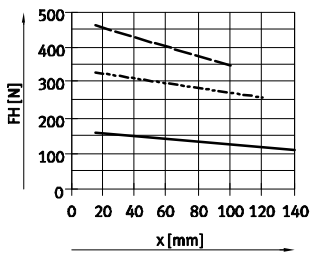

HGPT-50-A

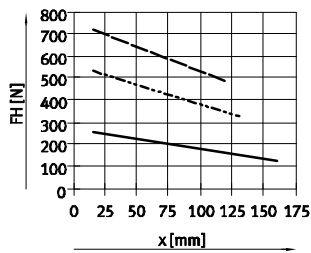

HGPT-63-A

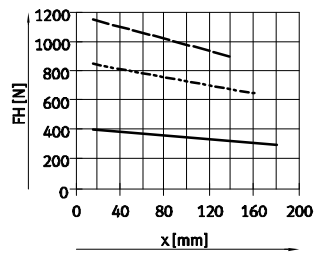

HGPT-80-A

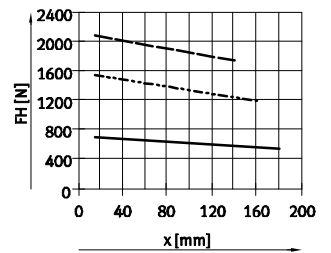

High force

HGPT-16-A-F

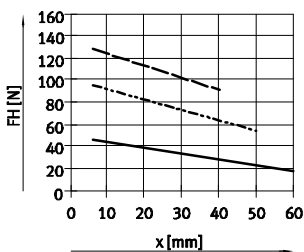

HGPT-20-A-F

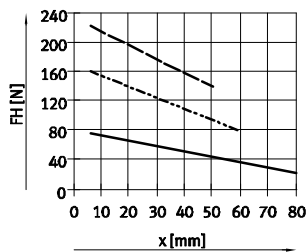

HGPT-25-A-F

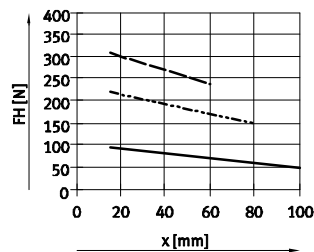

HGPT-35-A-F

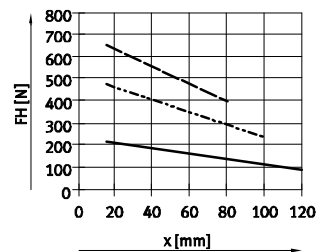

HGPT-40-A-F

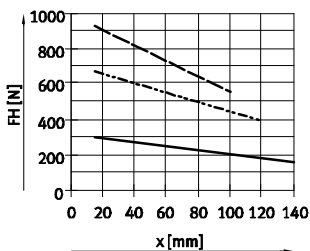

HGPT-50-A-F

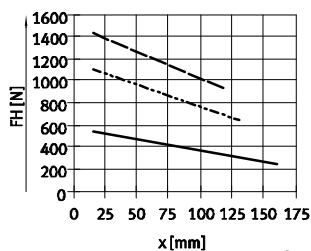

HGPT-63-A-F

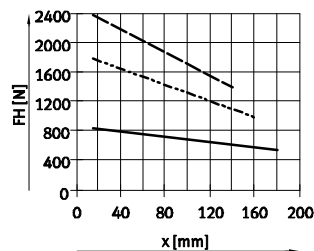

HGPT-80-A-F

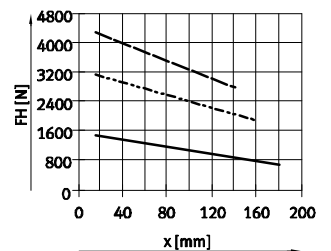

Parallel grippers HGPT-B, heavy-duty

Technical data



Gripping force F_H per gripper jaw as a function of operating pressure and lever arm x

The gripping forces as a function of operating pressure and lever arm can be determined from the following graphs.

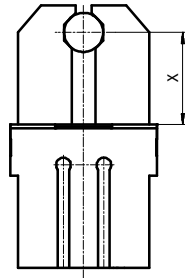

— 3 bar
 - - - 6 bar
 - · - 8 bar

Note
 Gripper selection
 sizing software
www.festo.com

Internal gripping (opening)

Standard

HGPT-16-A

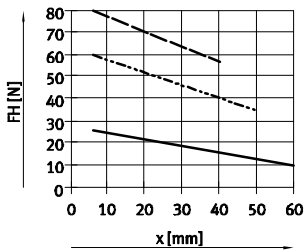

HGPT-20-A

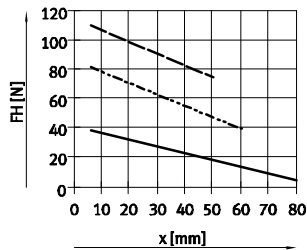

HGPT-25-A

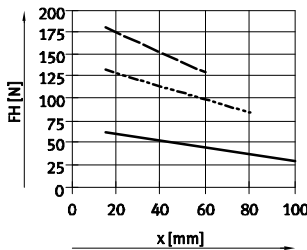

HGPT-35-A

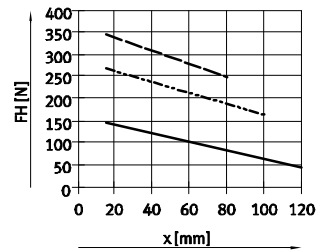

HGPT-40-A

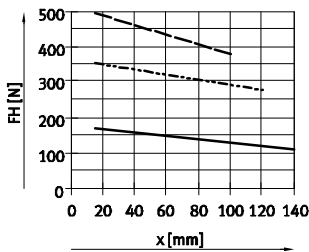

HGPT-50-A

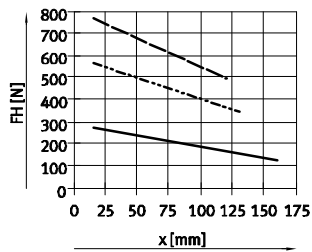

HGPT-63-A

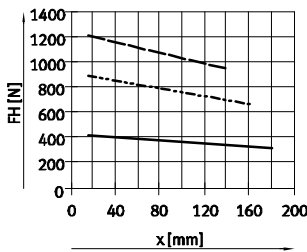

HGPT-80-A

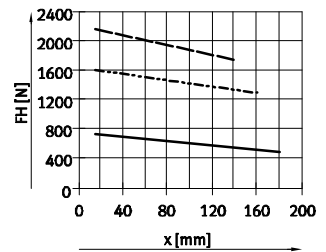

High force

HGPT-16-A-F

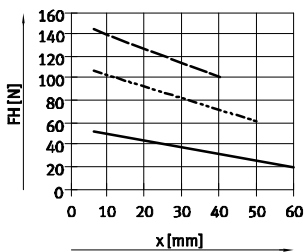

HGPT-20-A-F

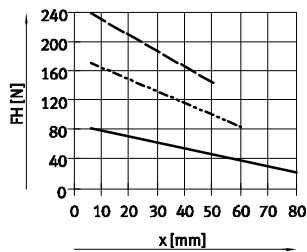

HGPT-25-A-F

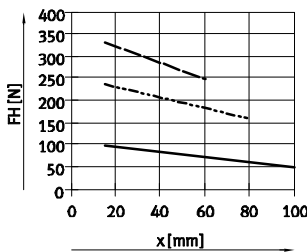

HGPT-35-A-F

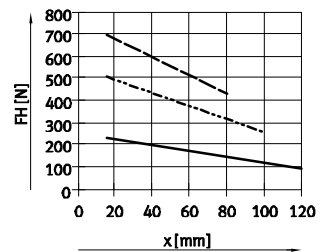

HGPT-40-A-F

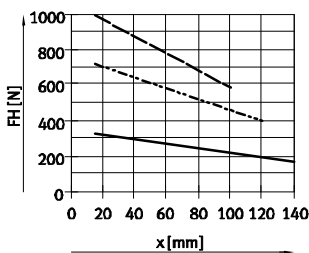

HGPT-50-A-F

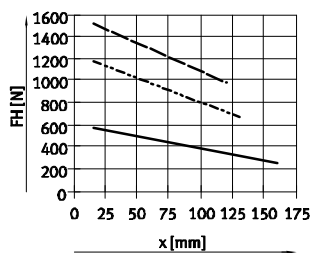

HGPT-63-A-F

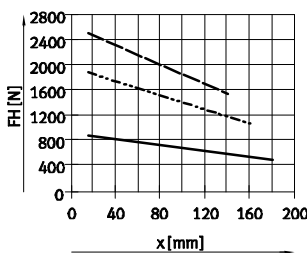

HGPT-80-A-F

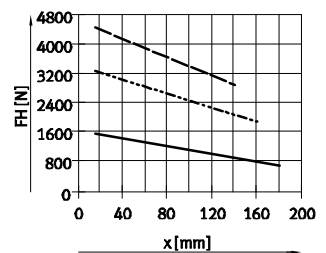

Parallel grippers HGPT-B, heavy-duty

Technical data

Gripping force F_H per gripper jaw at 6 bar as a function of lever arm x and eccentricity a and b

The following formula must be used to calculate the lever arm x with eccentric gripping:

$$x = \sqrt{a^2 + b^2}$$

The gripping force F_H can then be read from the graphs (→ from 11) using the calculated value x .

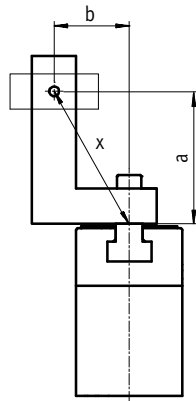

Calculation example

Given:

Distance $a = 45$ mm

Distance $b = 40$ mm

To be calculated:

The gripping force at 6 bar, with an HGPT-25, used as an external gripper

Procedure:

Calculate the lever arm x

$$x = \sqrt{45^2 + 40^2}$$

$x = 60$ mm

The graph (→ 11) gives a value of $F_H = 89$ N for the gripping force.

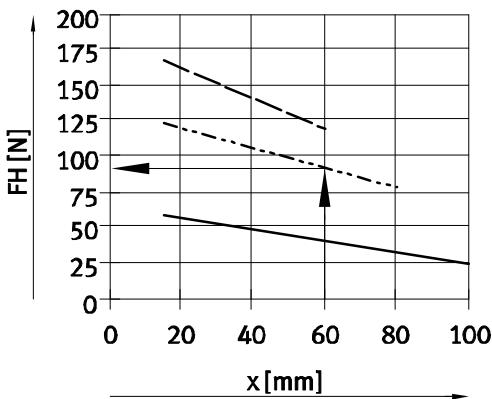

Parallel grippers HGPT-B, heavy-duty

Technical data

Spring force F_f as a function of size, gripper jaw stroke l

Gripping force retention for HGPT-...-G...

The spring forces F_f as a function of gripper jaw stroke l can be determined from the following graph.

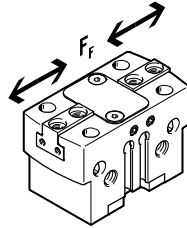

Standard

HGPT-...-A-G

Size 16 ... 35

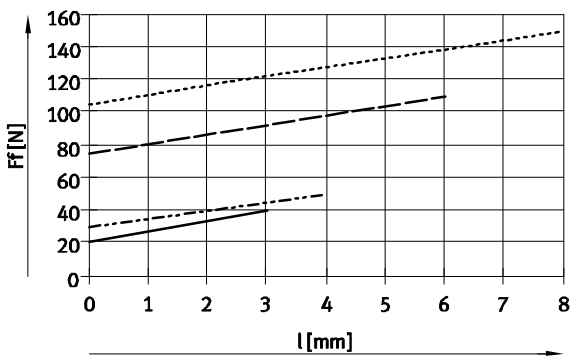

- HGPT-16-A-G
- - - HGPT-20-A-G
- - - - HGPT-25-A-G
- HGPT-35-A-G

High force

HGPT-...-A-F-G

Size 16 ... 35

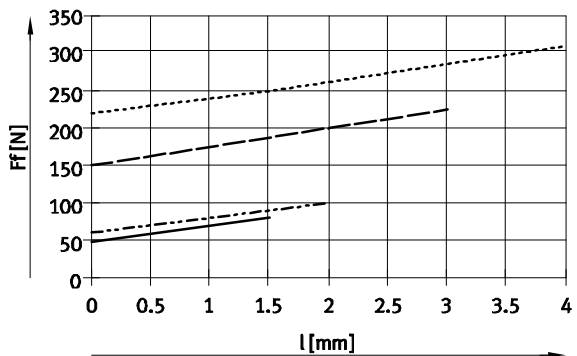

- HGPT-16-A-F-G
- - - HGPT-20-A-F-G
- - - - HGPT-25-A-F-G
- HGPT-35-A-F-G

Size 40 ... 80

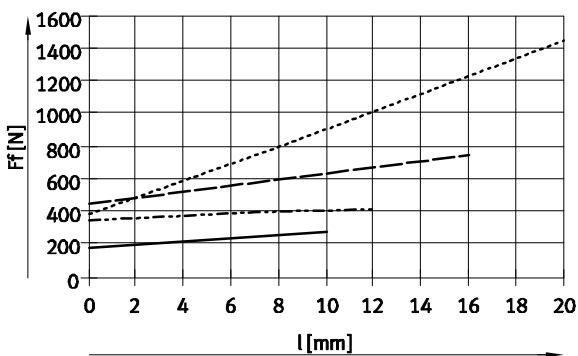

- HGPT-40-A-G
- - - HGPT-50-A-G
- - - - HGPT-63-A-G
- HGPT-80-A-G

Size 40 ... 80

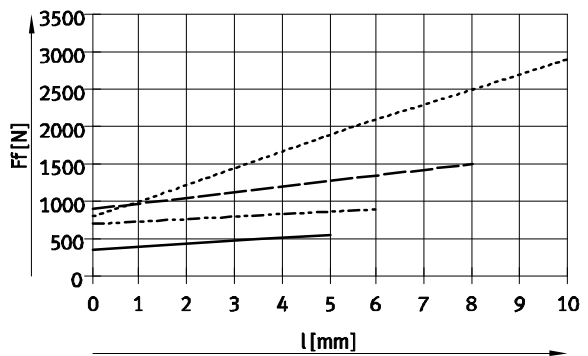

- HGPT-40-A-F-G
- - - HGPT-50-A-F-G
- - - - HGPT-63-A-F-G
- HGPT-80-A-F-G

Parallel grippers HGPT-B, heavy-duty

Technical data

FESTO

Spring force F_F as a function of size, gripper jaw stroke l and lever arm x per gripper finger

The lever arm x must be taken into consideration when determining the actual spring force F_{Ftotal} .

The formulae for calculating the spring force are provided in the table below.

Standard – HGPT-...-A-G

| Gripping force retention | Size | $F_{Ftotal} =$ |
|--------------------------|------|-------------------------|
| G1 | 16 | $-0.1 * x + 0.7 * F_F$ |
| | 20 | $-0.05 * x + 0.9 * F_F$ |
| | 25 | $-0.7 * x + 0.7 * F_F$ |
| | 35 | $-0.65 * x + 0.7 * F_F$ |
| | 40 | $-1.05 * x + 0.8 * F_F$ |
| | 50 | $-0.75 * x + 0.8 * F_F$ |
| | 63 | $-2 * x + 0.8 * F_F$ |
| | 80 | $-1.4 * x + 0.6 * F_F$ |

| Gripping force retention | Size | $F_{Ftotal} =$ |
|--------------------------|------|-------------------------|
| G2 | 16 | $-0.2 * x + 0.7 * F_F$ |
| | 20 | $-0.65 * x + 0.9 * F_F$ |
| | 25 | $-0.55 * x + 0.7 * F_F$ |
| | 35 | $-0.05 * x + 0.7 * F_F$ |
| | 40 | $-1.05 * x + 0.8 * F_F$ |
| | 50 | $-1.4 * x + 0.8 * F_F$ |
| | 63 | $-1.2 * x + 0.8 * F_F$ |
| | 80 | $-0.6 * x + 0.6 * F_F$ |

High force – HGPT-...-A-F-G

| Gripping force retention | Size | $F_{Ftotal} =$ |
|--------------------------|------|-------------------------|
| G1 | 16 | $-0.6 * x + 0.6 * F_F$ |
| | 20 | $-0.7 * x + 0.75 * F_F$ |
| | 25 | $-0.85 * x + 0.9 * F_F$ |
| | 35 | $-0.4 * x + 0.55 * F_F$ |
| | 40 | $-1.9 * x + 0.75 * F_F$ |
| | 50 | $-2.5 * x + 0.7 * F_F$ |
| | 63 | $-5.5 * x + 0.7 * F_F$ |
| | 80 | $-5.65 * x + 0.8 * F_F$ |

| Gripping force retention | Size | $F_{Ftotal} =$ |
|--------------------------|------|--------------------------|
| G2 | 16 | $-0.4 * x + 0.6 * F_F$ |
| | 20 | $-0.95 * x + 0.75 * F_F$ |
| | 25 | $-0.5 * x + 0.9 * F_F$ |
| | 35 | $-0.4 * x + 0.55 * F_F$ |
| | 40 | $-2.3 * x + 0.75 * F_F$ |
| | 50 | $-1 * x + 0.7 * F_F$ |
| | 63 | $-1 * x + 0.7 * F_F$ |
| | 80 | $-0.5 * x + 0.8 * F_F$ |

Determination of the actual gripping forces F_{Gr} for HGPT-...-G1 and HGPT-...-G2 as a function of the application

The parallel grippers with integrated spring type HGPT-...-G1 (opening gripping force retention) and HGPT-...-G2 (closing gripping force retention) can be used as:

- single-acting grippers

- grippers with supplementary gripping force and
- grippers with gripping force retention depending on requirements.

In order to calculate available gripping forces F_{Gr} (per gripper jaw),

the gripping force (F_H) and spring force (F_{Ftotal}) must be combined accordingly.

Application

Single-acting

- Gripping with spring force:
 $F_{Gr} = F_{Ftotal}$
- Gripping with pressure force:
 $F_{Gr} = F_H - F_{Ftotal}$

Supplementary gripping force

- Gripping with pressure and spring force:
 $F_{Gr} = F_H + F_{Ftotal}$

Gripping force retention

- Gripping with spring force:
 $F_{Gr} = F_{Ftotal}$

Parallel grippers HGPT-B, heavy-duty

Technical data

FESTO

Dimensions

Download CAD data → www.festo.com

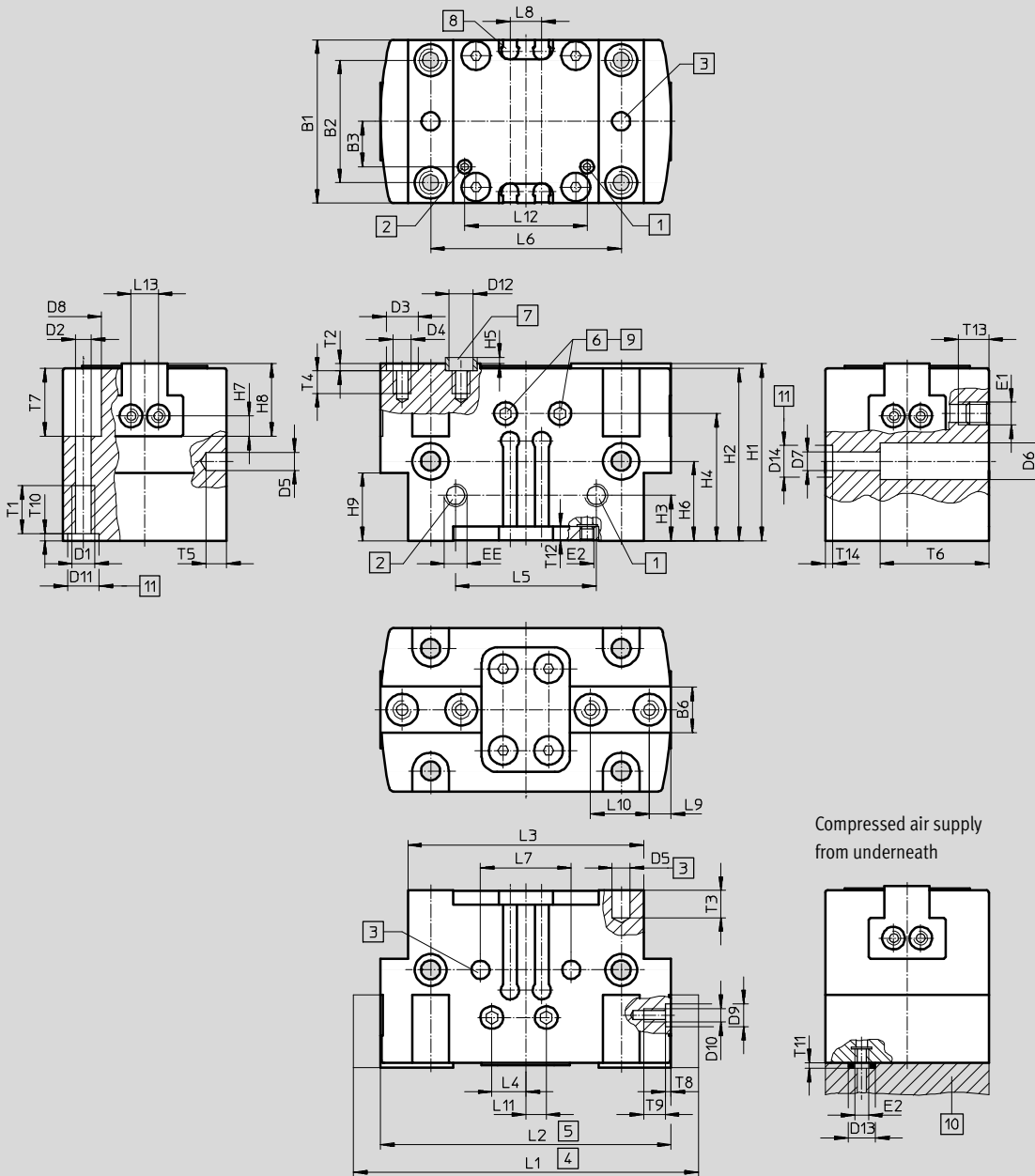

- 1 Supply port opening, either on the side or underneath (bottom port sealed on delivery)
- 2 Supply port closing, either on the side or underneath (bottom port sealed on delivery)

- 3 Hole for dowel pin (not included in the scope of delivery)
- 4 Gripper jaw open
- 5 Gripper jaw closed
- 6 Sealing air port (sealed on delivery)
- 7 Centring sleeves ZBH (4 included in the scope of delivery)

- 8 Slot for proximity sensor
- 9 Lubrication nipple (sealed on delivery)
- 10 O-ring for parallel gripper HGPT-16 ... 40: \varnothing 3x1.5
HGPT-50 ... 80: \varnothing 5x1.5
- 11 Hole for centring sleeve ZBH

Parallel grippers HGPT-B, heavy-duty

Technical data

| Size [mm] | B1 ±0.05 | B2 ¹⁾ | B3 ±0.1 | B6 -0.05 -0.1 | D1 | D2 ∅ | D3 ∅ H8/h7 | D4 | D5 ∅ H8 | D6 ∅ ±0.1 | D7 ∅ | D8 ∅ +0.3 | D9 ∅ H8 | D10 | D11 ∅ H8 | D12 ∅ |
|------------------|-------------|------------------|------------|---------------------|-----|---------|------------------|-----|---------------|-----------------|---------|-----------------|---------------|-----|----------------|----------|
| 16 | 24 | 17 | 4 | 6 | M3 | 2.6 | 5 | M3 | 2 | 4.6 | 2.6 | 4.6 | - | M2 | 5 | 3.2 |
| 20 ²⁾ | 28 | 22 | 8.7 | 6.5 | M4 | 3.3 | 5 | M3 | 3 | 6 | 3.2 | 6 | 5 | M3 | 5 | 3.2 |
| 25 | 36 | 27 | 11 | 10 | M5 | 4.2 | 7 | M4 | 4 | 8 | 4.2 | 8 | 5 | M3 | 7 | 5.3 |
| 35 | 42 | 32 | 13 | 12 | M5 | 4.2 | 9 | M5 | 4 | 9.2 | 5.3 | 8 | 7 | M5 | 7 | 6.4 |
| 40 | 50 | 38 | 17 | 14 | M6 | 5.1 | 9 | M6 | 5 | 11 | 6.4 | 9 | 7 | M5 | 9 | 6.4 |
| 50 | 60 | 45 | 20 | 15.5 | M8 | 6.8 | 9 | M6 | 6 | 13.5 | 8.4 | 11 | 7 | M5 | 12 | 6.4 |
| 63 | 72 | 56 | 24.5 | 20 | M8 | 6.8 | 12 | M10 | 6 | 13.5 | 8.4 | 11 | 7 | M5 | 12 | 10.3 |
| 80 | 100 | 70 | 39.5 | 22 | M10 | 8.5 | 15 | M12 | 8 | 16.5 | 10.2 | 13.5 | 9 | M6 | 12 | 12.4 |

| Size [mm] | D13 ∅ | D14 ∅ H8/h7 | EE | E1 | E2 | H1 | | H2 | | H3 | | H4 | | H5 -0.3 | H6 ¹⁾ | |
|--------------|----------|-------------------|----|----|----|-------|-------------|-------|-------------|------|------------|------|------|------------|------------------|------|
| | | | | | | ±0.05 | -G ±0.05 | ±0.05 | -G ±0.05 | ±0.1 | -G ±0.1 | | -G | | | -G |
| 16 | 6 | - | M5 | M3 | M3 | 29 | 37 | 28 | 36 | 12 | 12 | 23.7 | 31.7 | 1.2 | 17.5 | 25.5 |
| 20 | 6 | - | M5 | M3 | M3 | 31 | 38 | 30 | 37 | 10 | 15 | 23 | 30 | 1.2 | 14.5 | 21.5 |
| 25 | 6 | 7 | M5 | M5 | M3 | 39 | 57 | 38 | 56 | 10 | 20 | 28 | 46 | 1.4 | 17.5 | 35.5 |
| 35 | 6 | 7 | M5 | M5 | M3 | 49 | 67 | 48 | 66 | 12 | 30 | 36 | 54 | 1.9 | 20 | 38 |
| 40 | 6 | 9 | M5 | M5 | M3 | 55 | 81 | 54 | 80 | 15 | 36 | 41 | 67 | 1.9 | 25 | 51 |
| 50 | 8 | 12 | G½ | M5 | M5 | 63 | 93 | 62 | 92 | 15 | 30 | 47 | 77 | 1.9 | 30 | 60 |
| 63 | 8 | 12 | G½ | M5 | M5 | 77 | 117 | 76 | 116 | 18 | 26 | 56 | 96 | 2.4 | 28 | 68 |
| 80 | 8 | 12 | G¼ | M5 | M5 | 91 | 133 | 90 | 132 | 22 | 33 | 65 | 107 | 2.9 | 34 | 76 |

| Size [mm] | H7 ¹⁾ | H8 -0.02 | H9 | | L1 | | L2 ±0.5 | L3 ±0.1 | L4 ±0.5 | L5 ±0.1 | L6 ¹⁾ | L7 ¹⁾ | L8 +0.1 | L9 ¹⁾ | L10 ¹⁾ | L11 ±0.5 |
|--------------|------------------|-------------|------|------------|------|------------|------------|------------|------------|------------|------------------|------------------|------------|------------------|-------------------|-------------|
| | | | ±0.1 | -G ±0.1 | ±0.5 | -F ±0.5 | | | | | | | | | | |
| 16 | 2.25 | 8.5 | 15 | 23 | 50 | 47 | 44 | 36 | 5.5 | 20 | 29 | 20 | 6 | 3 | 8 | 1 |
| 20 | 3 | 12 | 15 | 22 | 64 | 60 | 56 | 44 | 2.5 | 24 | 35 | 24 | 6 | 3.25 | 12 | 2.5 |
| 25 | 4.5 | 16 | 15 | 33 | 76 | 70 | 64 | 52 | 3.5 | 31 | 42 | 20 | 7 | 4.75 | 13 | 3.5 |
| 35 | 5.5 | 19 | 20 | 38 | 96 | 88 | 80 | 64 | 5.5 | 40 | 52 | 40 | 7 | 5.5 | 16 | 5.5 |
| 40 | 5.5 | 22 | 24 | 50 | 120 | 110 | 100 | 80 | 5.5 | 49 | 66 | 50 | 10 | 6.5 | 20 | 5.5 |
| 50 | 7.5 | 25.5 | 26 | 56 | 149 | 137 | 125 | 100 | 5.5 | 63 | 82 | 60 | 10 | 8 | 24 | 5.5 |
| 63 | 9 | 32 | 32 | 72 | 192 | 176 | 160 | 125 | 5.5 | 74 | 100 | 76 | 10 | 9.5 | 32 | 5.5 |
| 80 | 11 | 39 | 34 | 77 | 230 | 205 | 180 | 154 | 5.5 | 82 | 130 | 100 | 10 | 12 | 40 | 5.5 |

| Size [mm] | L12 ±0.1 | L13 ¹⁾ | T1 min. | T2 +0.1 | T3 min. | T4 min. | T5 min. | T6 | T7 | | T8 +0.1 | T9 | T10 +0.1 | T11 | T12 min. | T13 min. | T14 +0.1 |
|--------------|-------------|-------------------|------------|------------|------------|------------|------------|----|------|------------|------------|----|-------------|-----|-------------|-------------|-------------|
| | | | | | | | | | +0.2 | -G +0.2 | | | | | | | |
| 16 | 22 | 6 | 5.5 | 1.3 | 4 | 5 | 4 | 15 | 14 | 22 | - | 3 | 1.3 | 1.2 | 3 | 5.5 | - |
| 20 | 22.6 | 6 | 6.5 | 1.3 | 5 | 5.5 | 4 | 19 | 11 | 11 | 1.3 | 6 | 1.3 | 1.2 | 3 | 5.5 | - |
| 25 | 29 | 6 | 8.5 | 1.6 | 6 | 6.5 | 4.5 | 24 | 15 | 15 | 1.3 | 6 | 1.6 | 1.2 | 3 | 6.7 | 1.6 |
| 35 | 39 | 13 | 8.5 | 2.1 | 6 | 8.5 | 4.5 | 16 | 19 | 19 | 1.6 | 9 | 1.6 | 1.2 | 3 | 6.5 | 1.6 |
| 40 | 47.4 | 13 | 10.5 | 2.1 | 6 | 10.5 | 6 | 33 | 20 | 20 | 1.6 | 9 | 2.1 | 1.2 | 4 | 6.5 | 2.1 |
| 50 | 61 | 13 | 12.5 | 2.1 | 8 | 10.5 | 6 | 43 | 23 | 23 | 1.6 | 9 | 2.6 | 1.2 | 4 | 6.5 | 2.6 |
| 63 | 75 | 13 | 12.5 | 2.6 | 8 | 15.5 | 7 | 55 | 35 | 35 | 1.6 | 9 | 2.6 | 1.2 | 5 | 6.5 | 2.6 |
| 80 | 82 | 20 | 15 | 3.1 | 10 | 20 | 10 | 70 | 44 | 44 | 2.1 | 10 | 2.6 | 1.2 | 5.5 | 5 | 2.6 |

1) Tolerance for centring hole ±0.02 mm
Tolerance for thread ±0.1 mm
2) Dowel pins [3] must be used when mounted from below.
-||- Note: This product conforms to ISO 1179-1 and to ISO 228-1

Parallel grippers HGPT-B, heavy-duty



Technical data

| Ordering data | | | | | | |
|---------------|---|---------------|--|------------------|----------|------------------|
| Size [mm] | Double-acting without compression spring | | Single-acting or with gripping force retention | | | |
| | Part No. | Type | Opening | | Closing | |
| | Part No. | Type | Part No. | Type | Part No. | Type |
| Standard | | | | | | |
| 16 | 560192 | HGPT-16-A-B | 560193 | HGPT-16-A-B-G1 | 560194 | HGPT-16-A-B-G2 |
| 20 | 560198 | HGPT-20-A-B | 560199 | HGPT-20-A-B-G1 | 560200 | HGPT-20-A-B-G2 |
| 25 | 560204 | HGPT-25-A-B | 560205 | HGPT-25-A-B-G1 | 560206 | HGPT-25-A-B-G2 |
| 35 | 560210 | HGPT-35-A-B | 560211 | HGPT-35-A-B-G1 | 560212 | HGPT-35-A-B-G2 |
| 40 | 560216 | HGPT-40-A-B | 560217 | HGPT-40-A-B-G1 | 560218 | HGPT-40-A-B-G2 |
| 50 | 560222 | HGPT-50-A-B | 560223 | HGPT-50-A-B-G1 | 560224 | HGPT-50-A-B-G2 |
| 63 | 560228 | HGPT-63-A-B | 560229 | HGPT-63-A-B-G1 | 560230 | HGPT-63-A-B-G2 |
| 80 | 560234 | HGPT-80-A-B | 560235 | HGPT-80-A-B-G1 | 560236 | HGPT-80-A-B-G2 |
| High force | | | | | | |
| 16 | 560195 | HGPT-16-A-B-F | 560196 | HGPT-16-A-B-F-G1 | 560197 | HGPT-16-A-B-F-G2 |
| 20 | 560201 | HGPT-20-A-B-F | 560202 | HGPT-20-A-B-F-G1 | 560203 | HGPT-20-A-B-F-G2 |
| 25 | 560207 | HGPT-25-A-B-F | 560208 | HGPT-25-A-B-F-G1 | 560209 | HGPT-25-A-B-F-G2 |
| 35 | 560213 | HGPT-35-A-B-F | 560214 | HGPT-35-A-B-F-G1 | 560215 | HGPT-35-A-B-F-G2 |
| 40 | 560219 | HGPT-40-A-B-F | 560220 | HGPT-40-A-B-F-G1 | 560221 | HGPT-40-A-B-F-G2 |
| 50 | 560225 | HGPT-50-A-B-F | 560226 | HGPT-50-A-B-F-G1 | 560227 | HGPT-50-A-B-F-G2 |
| 63 | 560231 | HGPT-63-A-B-F | 560232 | HGPT-63-A-B-F-G1 | 560233 | HGPT-63-A-B-F-G2 |
| 80 | 560237 | HGPT-80-A-B-F | 560238 | HGPT-80-A-B-F-G1 | 560239 | HGPT-80-A-B-F-G2 |

Parallel grippers HGPT-B, heavy-duty

Accessories

FESTO

Adapter kit
DHAA, HAPG

Material:
Wrought aluminium alloy
Free of copper and PTFE
RoHS-compliant

 Note
The kit includes the individual mounting interface as well as the necessary mounting material.

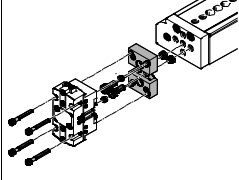
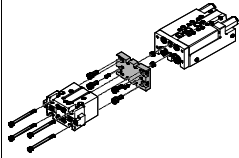
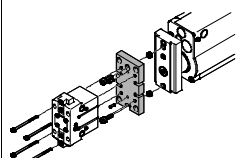
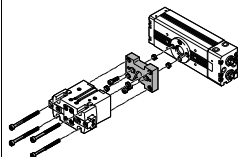
| Permissible drive/gripper combinations with adapter kit | | | | | Download CAD data → www.festo.com | | |
|---|-----------|---------|-----------------|------|--|-------------|--------------------|
| Combination | Drive | Gripper | Mounting option | | Adapter kit | | |
| | | | Size | Size | CRC ¹⁾ | Part No. | Type |
| | | | | | | | |
|  | DGSL | HGPT-B | | | DHAA, HAPG | | |
| | 8, 10 | 16, 20 | ■ | ■ | 2 | 564957 | DHAA-G-G6-8-B8-16 |
| | 12, 16 | 16, 20 | ■ | ■ | | 564954 | DHAA-G-G6-16-B8-16 |
| | 12, 16 | 25 | ■ | ■ | | 564952 | DHAA-G-G6-16-B8-25 |
| | 20, 25 | 25, 35 | ■ | ■ | | 537175 | HAPG-79 |
| | 20, 25 | 40 | ■ | ■ | | 564951 | DHAA-G-G6-20-B8-40 |
| | | | | | | | |
|  | SLT | HGPT-B | | | DHAA, HAPG | | |
| | 6 | 16 | ■ | – | 2 | 537168 | HAPG-74 |
| | 10 | 16, 20 | ■ | – | | 564957 | DHAA-G-G6-8-B8-16 |
| | 16 | 16, 20 | ■ | – | | 564954 | DHAA-G-G6-16-B8-16 |
| | 16 | 25 | ■ | – | | 564952 | DHAA-G-G6-16-B8-25 |
| | 20 | 25, 35 | ■ | – | | 537175 | HAPG-79 |
| | 25 | 35 | ■ | – | | 564953 | DHAA-G-H2-20-B8-35 |
| | 25 | 40 | ■ | – | | 564951 | DHAA-G-G6-20-B8-40 |
| | | | | | | | |
|  | HMP | HGPT-B | | | DHAA, HAPG | | |
| | 16 | 25 | – | ■ | 2 | 537178 | HAPG-81 |
| | 20, 25 | 35 | – | ■ | | 564953 | DHAA-G-H2-20-B8-35 |
| | 20, 25 | 40 | – | ■ | | 537182 | HAPG-84 |
| | 25, 32 | 50 | – | ■ | | 537185 | HAPG-86 |
| | 32 | 63 | – | ■ | | 537187 | HAPG-87 |
| | | | | | | | |
|  | DRQD-... | HGPT-B | | | DHAA, HAPG | | |
| | 12, 16 | 16 | ■ | ■ | 2 | 564958 | DHAA-G-Q5-12-B8-16 |
| | 12, 16 | 20 | ■ | ■ | | 564955 | DHAA-G-Q5-16-B8-20 |
| | 16, 20 | 25 | ■ | ■ | | 537181 | HAPG-SD2-25 |
| | 20, 25 | 35 | ■ | ■ | | 537173 | HAPG-SD2-23 |
| | 25, 32 | 40 | ■ | ■ | | 537184 | HAPG-SD2-26 |
| | 32, 40 | 50 | ■ | ■ | | 564956 | DHAA-G-Q5-32-B8-50 |
| | 40, 50 | 63 | ■ | ■ | | 537188 | HAPG-SD2-28 |
| | | | | | | | |
| | DRQD-E422 | HGPT-B | | | DHAA, HAPG | | |
| | 16 | 16, 20 | ■ | ■ | 2 | 564959 | DHAA-G-Q5-16-B8-16 |
| | 16, 20 | 25 | ■ | ■ | | 544642 | HAPG-SD2-48 |
| | 20 | 35 | ■ | ■ | | 544642 | HAPG-SD2-48 |
| | DRQD-E444 | HGPT-B | | | HAPG | | |
| 32 | 50 | ■ | ■ | 2 | 544643 | HAPG-SD2-49 | |

1) Corrosion resistance class 2 according to Festo standard 940 070
Components subject to moderate corrosion stress. Externally visible parts with primarily decorative surface requirements which are in direct contact with a normal industrial environment or media such as coolants or lubricating agents.

Parallel grippers HGPT-B, heavy-duty



Accessories



Adapter kit
DHAA, HAPG

Material:
Wrought aluminium alloy
Free of copper and PTFE
RoHS-compliant

 Note
The kit includes the individual mounting interface as well as the necessary mounting material.

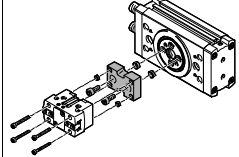
| Permissible drive/gripper combinations with adapter kit | | | | | Download CAD data → www.festo.com | |
|---|---------------|-----------------|---|---|--|---------------------------------|
| Combination | Drive Size | Gripper Size | Mounting option | | Adapter kit | |
| | | |  |  | CRC ¹⁾ | Part No. Type |
| | | | | | | |
|  | DRRD | HGPT-B | | | DHAA | |
| | 12 | 16 | ■ | ■ | 2 | 2449927 DHAA-G-Q11-12-B8/B8G-16 |
| | 12 | 20 | ■ | ■ | | 2449921 DHAA-G-Q11-12-B8-20 |
| | 16 | 16 | ■ | ■ | | 2091740 DHAA-G-Q11-16-B8/B8G-16 |
| | 16 | 20 | ■ | ■ | | 2091577 DHAA-G-Q11-16-B8-20 |
| | 16 | 25 | ■ | ■ | | 2090543 DHAA-G-Q11-16-B8-25 |
| | 20 | 25 | ■ | ■ | | 2088114 DHAA-G-Q11-20-B8-25 |
| | 20 | 35 | ■ | ■ | | 2087524 DHAA-G-Q11-20-B8-35 |
| | 25 | 35 | ■ | ■ | | 1731604 DHAA-G-Q11-25-B8-35 |
| | 25 | 40 | ■ | ■ | | 1731735 DHAA-G-Q11-25-B8-40 |
| | 32 | 40 | ■ | ■ | | 2092070 DHAA-G-Q11-32-B8-40 |
| | 35 | 40 | ■ | ■ | | 2114241 DHAA-G-Q11-35-B8-40 |
| | 32 | 50 | ■ | ■ | | 2118750 DHAA-G-Q11-32-B8-50 |
| | 35, 40 | 50 | ■ | ■ | | 2124990 DHAA-G-Q11-35/40-B8-50 |
| | 40 | 63 | ■ | ■ | | 2125264 DHAA-G-Q11-40-B8-63 |
| | 50 | 63 | ■ | ■ | | 2424526 DHAA-G-Q11-50-B8-63 |
| | 50 | 80 | ■ | ■ | | 2424527 DHAA-G-Q11-50-B8-80 |
| | DRRD | HGPT-B-G | | | DHAA | |
| | 12 | 16 | ■ | ■ | 2 | 2449927 DHAA-G-Q11-12-B8/B8G-16 |
| | 12 | 20 | ■ | ■ | | 2800827 DHAA-G-Q11-12-B8G-20 |
| | 16 | 16 | ■ | ■ | | 2091740 DHAA-G-Q11-16-B8/B8G-16 |
| | 16 | 20 | ■ | ■ | | 2595935 DHAA-G-Q11-16-B8G-20 |
| | 16 | 25 | ■ | ■ | | 2596187 DHAA-G-Q11-16-B8G-25 |
| | 20 | 25 | ■ | ■ | | 2596248 DHAA-G-Q11-20-B8G-25 |
| | 20 | 35 | ■ | ■ | | 2596517 DHAA-G-Q11-20-B8G-35 |
| | 25 | 35 | ■ | ■ | | 2597040 DHAA-G-Q11-25-B8G-35 |
| | 25 | 40 | ■ | ■ | | 2597322 DHAA-G-Q11-25-B8G-40 |
| | 32 | 40 | ■ | ■ | | 2597387 DHAA-G-Q11-32-B8G-40 |
| | 35 | 40 | ■ | ■ | | 2597928 DHAA-G-Q11-35-B8G-40 |
| | 32 | 50 | ■ | ■ | | 2597428 DHAA-G-Q11-32-B8G-50 |
| | 35, 40 | 50 | ■ | ■ | | 2604977 DHAA-G-Q11-35/40-B8G-50 |
| | 40 | 63 | ■ | ■ | | 2604813 DHAA-G-Q11-40-B8G-63 |
| 50 | 63 | ■ | ■ | 2604845 DHAA-G-Q11-50-B8G-63 | | |
| 50 | 80 | ■ | ■ | 2604887 DHAA-G-Q11-50-B8G-80 | | |

1) Corrosion resistance class 2 according to Festo standard 940 070
Components subject to moderate corrosion stress. Externally visible parts with primarily decorative surface requirements which are in direct contact with a normal industrial environment or media such as coolants or lubricating agents.

Parallel grippers HGPT-B, heavy-duty

Accessories

FESTO

Adapter kit
DHAA, HAPG

Material:
Wrought aluminium alloy
Free of copper and PTFE
RoHS-compliant

 Note
The kit includes the individual mounting interface as well as the necessary mounting material.

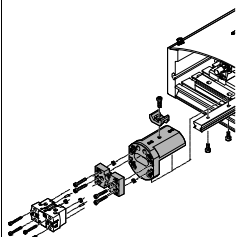
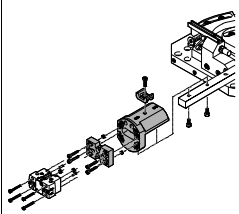
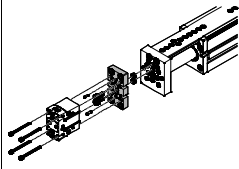
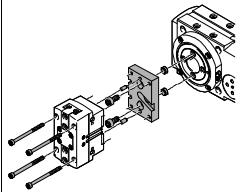
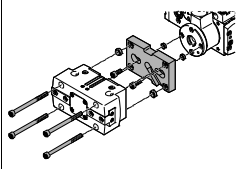
| Permissible drive/gripper combinations with adapter kit | | | | | Download CAD data → www.festo.com | | |
|---|------------|---------|-----------------|--------|--|-------------------|--------------------|
| Combination | Drive | Gripper | Mounting option | | Adapter kit | | |
| | | | Size | Size | CRC ¹⁾ | Part No. | Type |
| | | | | | | | |
|  | HSP | HGPT-B | | | DHAA, HAPG | | |
| | 12 | 16 | ■ | – | 2 | 564957 | DHAA-G-G6-8-B8-16 |
| | | | | | | 540881 | HAPG-70-B |
| | 16 | 16, 20 | ■ | – | | 564957 | DHAA-G-G6-8-B8-16 |
| | | | | 540882 | HAPG-71-B | | |
| | 25 | 16, 20 | ■ | – | 564957 | DHAA-G-G6-8-B8-16 | |
| | | | | | 540883 | HAPG-72-B | |
|  | HSW | HGPT-B | | | DHAA, HAPG | | |
| | 12 | 16 | ■ | – | 2 | 564957 | DHAA-G-G6-8-B8-16 |
| | | | | | | 540882 | HAPG-71-B |
| | 16 | 16, 20 | ■ | – | 564957 | DHAA-G-G6-8-B8-16 | |
| | | | | | 540882 | HAPG-71-B | |
|  | EGSL | HGPT-B | | | DHAA, HAPG | | |
| | 45, 55 | 25 | ■ | ■ | 2 | 564952 | DHAA-G-G6-16-B8-25 |
| | | | | | | 564951 | DHAA-G-G6-20-B8-40 |
| | 75 | 40 | ■ | ■ | | 537175 | HAPG-79 |
| | 75 | 25, 35 | ■ | ■ | | | |
|  | ERMB | HGPT-B | | | DHAA, HAPG | | |
| | 20 | 25 | ■ | ■ | 2 | 537181 | HAPG-SD2-25 |
| | | | | | | 537173 | HAPG-SD2-23 |
| | 20, 25 | 35 | ■ | ■ | | 537184 | HAPG-SD2-26 |
| | 25, 32 | 40 | ■ | ■ | | 564956 | DHAA-G-Q5-32-B8-50 |
| | 32 | 50 | ■ | ■ | | | |
|  | EHMB | HGPT-B | | | DHAA, HAPG | | |
| | 20 | 40 | ■ | ■ | 2 | 537184 | HAPG-SD2-26 |
| | | | | | | 564956 | DHAA-G-Q5-32-B8-50 |
| | 20, 25, 32 | 50 | ■ | ■ | | 537188 | HAPG-SD2-28 |
| | 25, 32 | 63 | ■ | ■ | | | |

1) Corrosion resistance class 2 according to Festo standard 940 070
Components subject to moderate corrosion stress. Externally visible parts with primarily decorative surface requirements which are in direct contact with a normal industrial environment or media such as coolants or lubricating agents.

Parallel grippers HGPT-B, heavy-duty



Accessories

Gripper jaw blank BUB-HGPT
(scope of delivery: 2 pieces)

Material:
Aluminium

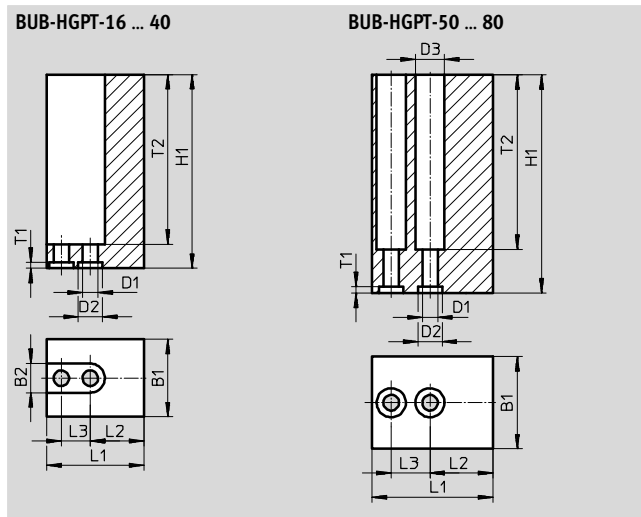



| Dimensions and ordering data | | | | | | | |
|------------------------------|-------|-----|-------|------|-------|-------|-------|
| For size | B1 | B2 | D1 | D2 | D3 | H1 | L1 |
| [mm] | ±0.05 | H13 | ∅ H13 | ∅ H8 | ∅ H13 | ±0.05 | ±0.05 |
| 16 | 16 | 6 | 3.2 | 5 | - | 40 | 21 |
| 20 | 19 | 6 | 3.2 | 5 | - | 45 | 27 |
| 25 | 24 | 8 | 4.3 | 7 | - | 60 | 31 |
| 35 | 28 | 10 | 5.3 | 9 | - | 70 | 39 |
| 40 | 34 | 11 | 6.4 | 9 | - | 75 | 49 |
| 50 | 40 | - | 6.4 | 9 | 11 | 100 | 61 |
| 63 | 50 | - | 10.3 | 12 | 17 | 120 | 79 |
| 80 | 58 | - | 12.4 | 15 | 20 | 140 | 88 |

| For size | L2 ¹⁾ | L3 ¹⁾ | T1 | T2 | Weight per blank [g] | Part No. | Type |
|----------|------------------|------------------|------|------|----------------------|----------|---------------|
| [mm] | | | +0.1 | | | | |
| 16 | 10 | 8 | 1.3 | 35 | 29 | 560244 | BUB-HGPT-16-B |
| 20 | 11.75 | 12 | 1.3 | 36 | 53 | 560245 | BUB-HGPT-20-B |
| 25 | 13.25 | 13 | 1.6 | 51 | 98 | 560246 | BUB-HGPT-25-B |
| 35 | 17.5 | 16 | 2.1 | 61 | 161 | 560247 | BUB-HGPT-35-B |
| 40 | 22.5 | 20 | 2.1 | 66.5 | 280 | 560248 | BUB-HGPT-40-B |
| 50 | 29 | 24 | 2.1 | 91 | 622 | 560249 | BUB-HGPT-50-B |
| 63 | 37.5 | 32 | 2.6 | 110 | 1,213 | 560250 | BUB-HGPT-63-B |
| 80 | 36 | 40 | 3.1 | 125 | 1,738 | 560251 | BUB-HGPT-80-B |

1) Tolerance for centring hole ±0.02 mm
Tolerance for thread ±0.1 mm

Parallel grippers HGPT-B, heavy-duty

Accessories

| Ordering data | | | | | | |
|---|-----------------------|---|--|--------------------------------|-----------|------------------|
| | For size [mm] | Description | Weight [g] | Part No. | Type | PU ¹⁾ |
| Centring sleeve ZBH | | | Technical data → Internet: zbh | | | |
|  | 16, 20 | For centring gripper jaw blanks/gripper fingers on the gripper jaws | 1 | 189652 | ZBH-5 | 10 |
| | 25 | | 1 | 186717 | ZBH-7 | |
| | 35, 40, 50 | | 1 | 150927 | ZBH-9 | |
| | 63 | | 1 | 189653 | ZBH-12 | |
| | 80 | | 3 | 191409 | ZBH-15 | |
| | 20, 25 | For lateral centring of gripper fingers on the gripper jaws | 1 | 189652 | ZBH-5 | |
| | 35, 40, 50, 63 | | 1 | 186717 | ZBH-7 | |
| | 80 | | 1 | 150927 | ZBH-9 | |
| | 16, 20 | For centring the gripper during mounting | 1 | 189652 | ZBH-5 | |
| | 25, 35 | | 1 | 186717 | ZBH-7 | |
| | 40 | | 1 | 150927 | ZBH-9 | |
| | 50, 63, 80 | | 1 | 189653 | ZBH-12 | |
| | Connecting sleeve ZBV | | | Technical data → Internet: zbv | | |
|  | – | For compensating different centring diameters | 1 | 571033 | ZBV-6-5 | 1 |
| | | | 1 | 571034 | ZBV-8-7 | |
| | | | 1 | 560253 | ZBV-9-8 | |
| | | | 2 | 571035 | ZBV-12-10 | |
| | | | 2 | 560255 | ZBV-14-12 | |
| Blanking plug B | | | Technical data → Internet: blanking plug | | | |
|  | 16, 20 | For sealing the supply ports | 1 | 30979 | B-M3-S9 | 10 |
| | 25, 35, 40 | | 1 | 174308 | B-M5-B | |
| | 50, 63 | | 5 | 3568 | B-1/8 | |
| | 80 | | 15 | 3569 | B-1/4 | |

1) Packaging unit



Parallel grippers HGPT-B, heavy-duty

Accessories

FESTO

| Proximity sensors for size 16 ... 35 | | | | | | |
|---|-----------------------------------|---|------------------|------------------|----------|--------------------------------|
| Ordering data – Proximity sensors for C-slot, magneto-resistive | | | | | | Technical data → Internet: smt |
| | Type of mounting | Electrical connection, connection direction | Switching output | Cable length [m] | Part No. | Type |
| N/O contact | | | | | | |
|  | Insertable in the slot lengthwise | Cable, 3-wire, lateral | PNP | 2.5 | 547862 | SMT-10G-PS-24V-E-2,5Q-OE |
| | | Plug M8x1, 3-pin, lateral | | 0.3 | 547863 | SMT-10G-PS-24V-E-0,3Q-M8D |

| Proximity sensors for size 40 ... 80 | | | | | | |
|---|-----------------------------------|---|------------------|------------------|----------|--------------------------------|
| Ordering data – Proximity sensors for T-slot, magneto-resistive | | | | | | Technical data → Internet: smt |
| | Type of mounting | Electrical connection, connection direction | Switching output | Cable length [m] | Part No. | Type |
| N/O contact | | | | | | |
|  | Insertable in the slot lengthwise | Cable, 3-wire, lateral | PNP | 2.5 | 547859 | SMT-8G-PS-24V-E-2,5Q-OE |
| | | Plug M8x1, 3-pin, lateral | | 0.3 | 547860 | SMT-8G-PS-24V-E-0,3Q-M8D |

| Ordering data – Connecting cables | | | | | | Technical data → Internet: nebu |
|---|------------------------------|------------------------------|------------------|----------|---------------------|---------------------------------|
| | Electrical connection, left | Electrical connection, right | Cable length [m] | Part No. | Type | |
|  | Straight socket, M8x1, 3-pin | Cable, open end, 3-wire | 2.5 | 541333 | NEBU-M8G3-K-2.5-LE3 | |
| | | | 5 | 541334 | NEBU-M8G3-K-5-LE3 | |
|  | Angled socket, M8x1, 3-pin | Cable, open end, 3-wire | 2.5 | 541338 | NEBU-M8W3-K-2.5-LE3 | |
| | | | 5 | 541341 | NEBU-M8W3-K-5-LE3 | |

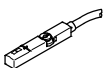
| Proximity sensors for size 40 ... 80 | | | | | | |
|---|-----------------------------------|---------------------|---|------------------|----------|---------------------------------|
| Ordering data – Position transmitters for T-slot | | | | | | Technical data → Internet: smat |
| | Type of mounting | Analogue output [V] | Electrical connection, connection direction | Cable length [m] | Part No. | Type |
|  | Insertable in the slot from above | 0 ... 10 | Plug M8x1, 4-pin, in-line | 0.3 | 553744 | SMAT-8M-U-E-0,3-M8D |

-  - Note

| | | | |
|--|--|---|--|
| <p>Mode of operation: The position transmitter continuously senses the position of the piston. It has an analogue output with an output signal that is proportional to the piston position.</p> | <p>Measuring range: Measurement is possible across the entire stroke with the sizes 40 and 50. A stroke of 13 mm (with the high-force variant 6.5 mm) can be measured with the sizes 63 and 80.</p> | <p>Two position transmitters are required for sensing longer strokes.</p> | <p>Projection: The position transmitter projects past the housing with the sizes 40 and 50.</p> |
|--|--|---|--|

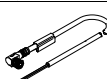
| Ordering data – Connecting cables | | | | | | Technical data → Internet: nebu |
|---|------------------------------|------------------------------|------------------|----------|---------------------|---------------------------------|
| | Electrical connection, left | Electrical connection, right | Cable length [m] | Part No. | Type | |
|  | Straight socket, M8x1, 4-pin | Cable, open end, 4-wire | 2.5 | 541342 | NEBU-M8G4-K-2.5-LE4 | |
| | | | 5 | 541343 | NEBU-M8G4-K-5-LE4 | |
|  | Angled socket, M8x1, 4-pin | Cable, open end, 4-wire | 2.5 | 541344 | NEBU-M8W4-K-2.5-LE4 | |
| | | | 5 | 541345 | NEBU-M8W4-K-5-LE4 | |