

## Angle seat valves VZXA

**FESTO**

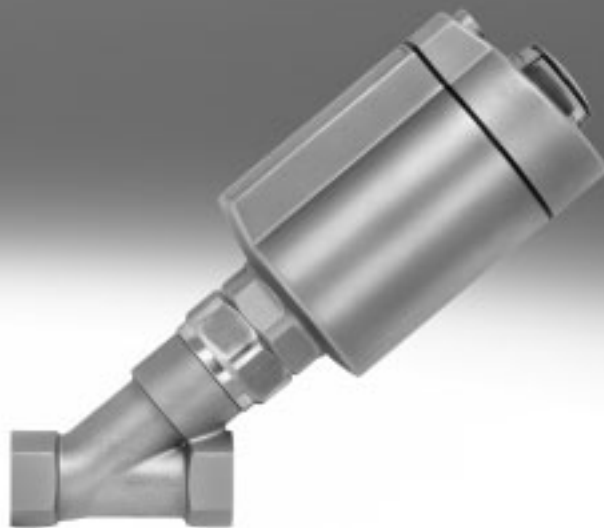

# Angle seat valves VZXA

Key features

FESTO

**Function**  
 The angle seat valves VZXA are externally actuated valves which are controlled by a direct supply of compressed air and are used to shut off gaseous or liquid media in pipe systems. In the process, a spindle with a soft-sealing valve disc is raised and lowered with the aid of a pneumatic actuator. In all the versions mentioned below, the valve seat is slanted around 40° toward the medium flow. The flow direction is determined by the design of the valve (process valve and actuator).

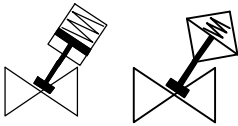
**NC version (normally closed)**  

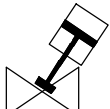
 In the normal position, the valve is closed by springs. When the actuator is supplied with operating pressure, it raises the control piston and, at the same time, the valve disc too – this opens the valve.

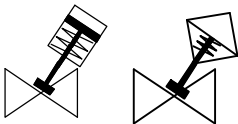
**DA version (double acting)**  

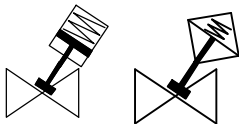
 The control function is performed by reciprocal pneumatic actuation of the actuator chambers. Only available with the piston actuator.

**NO version (normally open)**  

 In the normal position, the valve is opened by a spring. When the actuator is supplied with operating pressure, it lowers the control piston and, at the same time, the valve disc, too – this closes the valve.

**NC version (normally closed) with reduced spring force**  

 In the normal position the valve is closed by a spring (reduced spring force for low operating pressures). When the actuator is supplied with operating pressure, it raises the control piston and, at the same time, the valve disc too – this opens the valve.

**Economical**

- Modular design
- Hygienic design, insensitive to dirt
- Long service life
- Quick and easy maintenance
- High flow rates achievable

**Flexible**

- Control of medium flows (gaseous and liquid) in closed and open circuits
- The angle seat valves VZXA are simple and sturdy and are thus perfectly suitable for almost all media with a viscosity of up to 600 mm<sup>2</sup>/s
- Angle seat valves VZXA made from stainless steel with PTFE seals have high chemical and thermal resistance
- Temperature of medium –30 ... +200 °C

**Design**

- G thread to DIN ISO 228-1 Parallel Whitworth pipe thread, non-metallic seal: must either be provided with an annular seal outside the thread or must be sealed by wrapping the thread with PTFE or hemp
- NPT thread to ANSI/ASME B 1.20.1 American tapered pipe thread with sealing material in the thread, female thread tapered, male thread tapered
- Rc thread to DIN 10226-2 Pipe thread for fittings sealing in the thread, female thread tapered, male thread tapered
- Connection sizes DN13 ... DN50 and 1/2" ... 2"
- Medium pressure: 0 ... 30 bar
- Operating pressure: 5 ... 10 bar
- Threaded collar connection
- ATEX





- Piston actuator with low space requirement, can close against pressures up to 10 bar, in actuator sizes 46 mm and 75 mm
- Diaphragm actuator without stick-slip effect, ideal for high force requirements and control applications, in actuator size 90 mm
- Note: The interface screws between the valve body and the piston and diaphragm actuators are identical to spanner size AF46



# Angle seat valves VZXA

Product range overview

Product range overview			
	Type code	Control function	Flow direction
	VZXA-A...	<ul style="list-style-type: none"> <li>Closed via reduced spring force, N/C</li> </ul>	<ul style="list-style-type: none"> <li>Over valve seat</li> <li>For gaseous media, "closing in the direction of medium flow" is used</li> </ul>
	VZXA-B...	<ul style="list-style-type: none"> <li>Closed via spring force, NC</li> <li>Opened via spring force, NO</li> <li>Double-acting, DA</li> </ul>	<ul style="list-style-type: none"> <li>Under valve seat</li> <li>For gaseous and liquid media, "closing against the direction of medium flow" is used in order to prevent or reduce water hammer effects</li> </ul>

## Ordering data – Product options

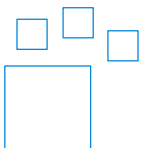

Configurable product  
This product and all its product options can be ordered using the configurator.

The configurator can be found under Products on the DVD or  
[→ www.festo.com/catalogue/...](http://www.festo.com/catalogue/...)

Part No. Type code  
**3539410 VZXA**

# Angle seat valves VZXA

Type codes

FESTO

VZXA - A - - T S7 - 1/2" - M2 - V14 T

## Type

VZXA	Process valve
------	---------------

## Direction of flow

A	Above valve seat for gaseous media
B	Below valve seat for gaseous and liquid media

## Control of the medium

-	On/off operation
---	------------------

## Line connection

T	Threaded collar
---	-----------------

## Connection standard

S6	DIN ISO 228-1
S7	ANSI/ASME B 1.20.1
S13	DIN 10226

## Connection size

1/2"	1/2"
3/4"	3/4"
1"	1"
1 1/2"	1 1/2"
1 1/4"	1 1/4"
2"	2"
13	DN13
20	DN20
25	DN25
32	DN32
40	DN40
50	DN50

## Temperature of medium

M2	-10 to +180 °C
M3	-30 to +200 °C

## Valve housing material

V13	Stainless steel 1.4409
V14	Stainless steel ASTM A351-CF3M

## Seat seal material

T	PTFE
TP	PTFE, modified

# Angle seat valves VZXA

Type codes

FESTO

- 16 - K - 46 - 17 - PR - - V4 -

Medium pressure	
4	0 ... 4 bar
4,4	0 ... 4.4 bar
4,8	0 ... 4.8 bar
5,6	0 ... 5.6 bar
5,8	0 ... 5.8 bar
6	0 ... 6 bar
6,2	0 ... 6.2 bar
6,8	0 ... 6.8 bar
7,5	0 ... 7.5 bar
8	0 ... 8 bar
8,3	0 ... 8.3 bar
9,3	0 ... 9.3 bar
10	0 ... 10 bar
11,5	0 ... 11.5 bar
12,2	0 ... 12.2 bar
12,8	0 ... 12.8 bar
13,5	0 ... 13.5 bar
14,5	0 ... 14.5 bar
15,5	0 ... 15.5 bar
16	0 ... 16 bar
23	0 ... 23 bar
25	0 ... 25 bar
30	0 ... 30 bar

Actuator	
K	Piston actuator
M	Diaphragm actuator

Actuator size	
46	46 mm
75	75 mm
90	90 mm

Stroke	
17	17 mm
20	20 mm
26	26 mm

Control function	
-	Closed via spring force, NC
D	Double-acting
S	Opened via spring force, NO
PR	Closed via reduced spring force, NC

Position sensing	
-	With mechanical indicator

Actuator housing material	
V4	Stainless steel 1.4408

EU certification	
-	None
EX4	II 2GD

# Angle seat valves VZXA with piston actuator

Technical data

Function

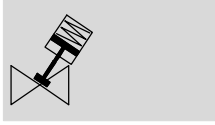

- Poppet valve with piston actuator
- Line connection  
1/2" ... 2", DN13 ... DN50
- Stroke  
17 ... 20 mm



General technical data										
Line connection		DN13, 1/2"	DN20, 3/4"	DN25, 1"		DN32, 1 1/4"		DN40, 1 1/2"	DN50, 2"	
Actuator		D46	D46	D75	D46	D75	D46	D75	D75	D75
Flow rate Kv	VZXA-A-... [m³/h]	6.6	–	14.5	–	21.5	–	–	–	–
	VZXA-B-... [m³/h]	6	13.3	13.5	20.3	22.6	27.9	30.3	41.4	50.1
Design		Poppet valve with piston actuator								
Type of actuation		Pneumatic								
Type of mounting		In-line installation								
Mounting position		Any								
Valve function		2/2								
Pneumatic connection		Female thread G1/8								
Flow direction		Non-reversible								
Reset method		Mechanical spring								
Type of actuation		Externally actuated								
Position sensing		With mechanical indicator								
Control of the medium		On/off operation								
Control function	VZXA-A-...	Closed via reduced spring force, NC								
	VZXA-B-...	Closed via spring force, NC								
Direction of flow	VZXA-A-...	Above valve seat for gaseous media								
	VZXA-B-...	Below valve seat for gaseous and liquid media								

# Angle seat valves VZXA with piston actuator

Technical data

Operating and environmental conditions	
Operating pressure [bar]	5 ... 10
Ambient temperature [°C]	0 ... +60
Temperature of medium [°C]	-10 ... +180
Storage temperature [°C]	-10 ... +60
CE mark (see declaration of conformity) <sup>1)</sup>	To EU Machinery Directive
Degree of protection	IP65
	IP67
	IP69K
Max. viscosity [mm <sup>2</sup> /s]	600
Medium  VZXA-B-... additionally	Vapour
	Inert gases
	Filtered compressed air, grade of filtration 200 µm
	Mineral oil-based hydraulic oil
	Mineral oil
	Water
	Neutral fluids
Operating medium	Compressed air to ISO 8573-1:2010 [7:4:4]
Safety Integrity Level (SIL)	SIL 2
PFH	0.00000014
PFD	0.000595
Certificate issuing authority	TÜV 968/V 1039.00/18

1) Additional information [www.festo.com/sp](http://www.festo.com/sp) → Certificates.

ATEX <sup>1)</sup>						
Connection size	DN13, 1/2"	DN20, 3/4"	DN25, 1"	DN32, 1 1/4"	DN40, 1 1/2"	DN50, 2"
ATEX category for gas	II 2G					
Type of ignition protection for gas	c T6 ... T3 X					
ATEX category for dust	II 2D					
Type of ignition protection for dust	c T80°C ... T200°C X					
Explosion ambient temperature [°C]	0°C ≤ Ta ≤ +60°C					

1) Specified types → [www.festo.com](http://www.festo.com)

# Angle seat valves VZXA with piston actuator

Technical data

Materials		Material number
Piston rod	High-alloy stainless steel	
End cap	Stainless steel casting	
Seals	FPM	
Spindle washer	PTFE	
Seat seal	PTFE	
Actuator housing	Stainless steel casting	1.4408
Valve housing	Stainless steel casting	1.4409
		ASTM A351-CF3M
Note on materials	Contains paint-wetting impairment substances	
	RoHS compliant	

Permissible operating pressure as a function of medium pressure for control function NC, VZXA-B-...				
Actuator size	Max. medium pressure [bar]		Min. operating pressure [bar]	
	46 mm	75 mm	46 mm	75 mm
DN13, 1/2"	30	–	4.8	–
DN20, 3/4"	12.8	30	4.8	4.6
DN25, 1"	8.3	23	4.8	4.6
DN32, 1 1/4"	4.4	13.5	4.8	4.6
DN40, 1 1/2"	–	9.3	–	4.6
DN50, 2"	–	5.6	–	4.6

## Permissible operating pressure p2 as a function of medium pressure p1 for control function NC, VZXA-A-...

Piston actuator size 46 mm

Piston actuator size 75 mm

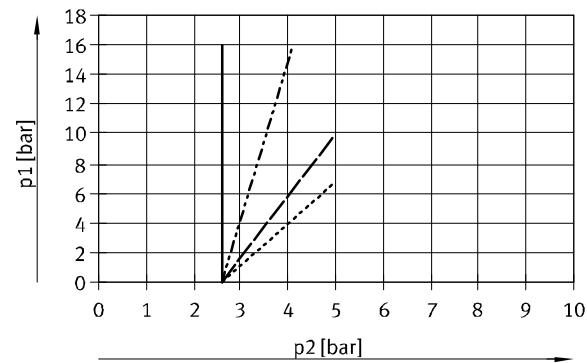

- DN13, 1/2"
- DN20, 3/4"
- DN25, 1"
- DN32, 1 1/4"

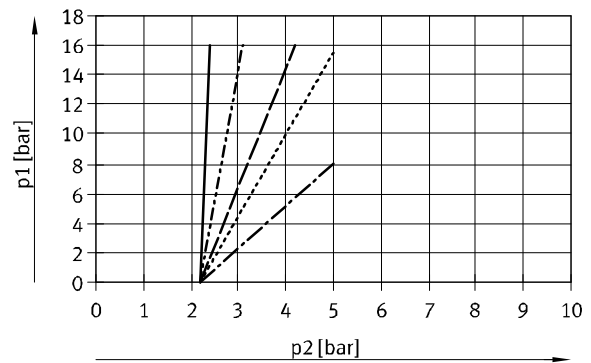

- DN20, 3/4"
- DN25, 1"
- DN32, 1 1/4"
- DN40, 1 1/2"
- DN50, 2"



# Angle seat valves VZXA with piston actuator

Technical data

FESTO

## Dimensions

Download CAD data → [www.festo.com](http://www.festo.com)

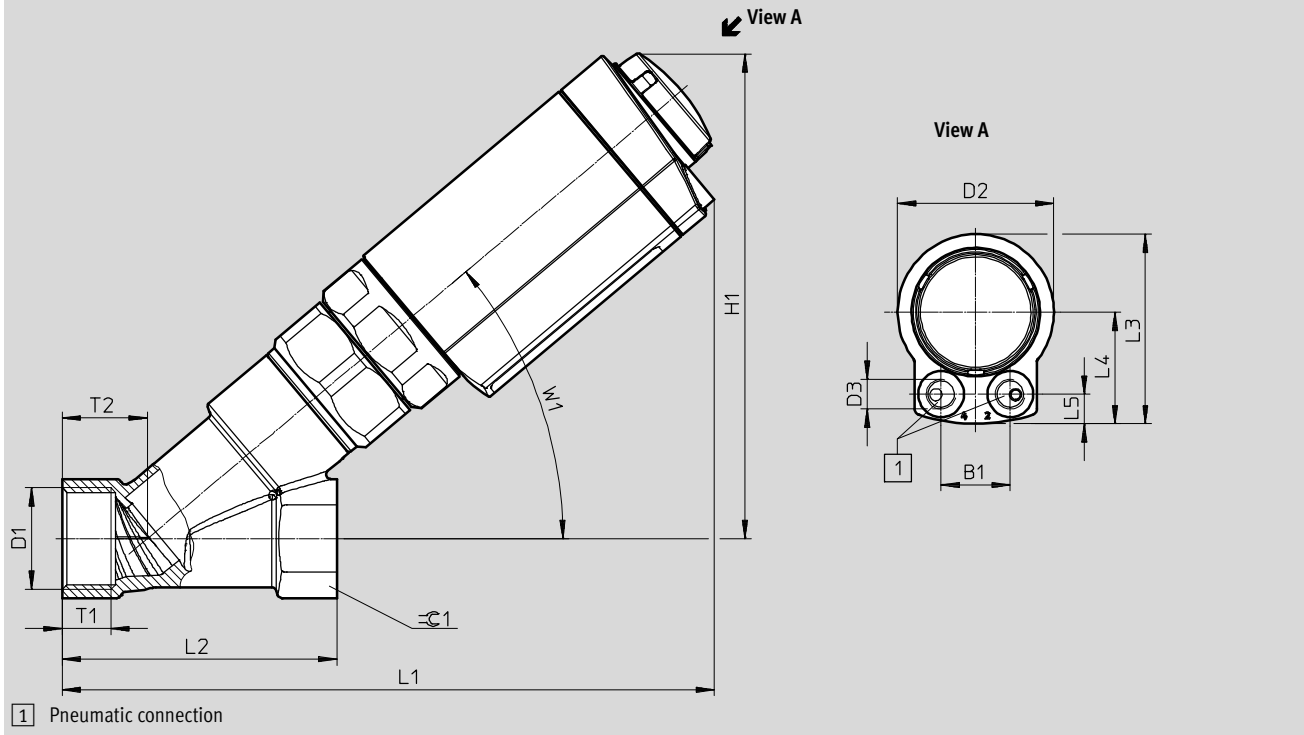

Type	B1	D1			D2 Ø	D3	H1	L1	L2
		S6	S7	S13					
VZXA-A-...-13-...-16-...-46-17-...	22.6	G1/2	1/2 NPT	Rc1/2	51	G1/8	159	202	65
VZXA-A-...-20-...-16-...-75-20-...	41	G3/4	3/4 NPT	Rc3/4	82.6		187	234	75
VZXA-A-...-25-...-16-...-75-20-...	41	G1	1" NPT	Rc1	82.6		192	244	90
VZXA-B-...-13-...-30-...-46-17-...	22.6	G1/2	1/2 NPT	Rc1/2	51		159	202	65
VZXA-B-...-20-...-12.8-...-46-17-...	22.6	G3/4	3/4 NPT	Rc3/4	51		158	203	75
VZXA-B-...-20-...-30-...-75-20-...	41	G3/4	3/4 NPT	Rc3/4	82.6		187	234	75
VZXA-B-...-25-...-8.3-...-46-17-...	22.6	G1	1" NPT	Rc1	51		164	214	90
VZXA-B-...-25-...-23-...-75-20-...	41	G1	1" NPT	Rc1	82.6		192	244	90
VZXA-B-...-32-...-4.4-...-46-17-...	22.6	G11/4	11/4 NPT	Rc11/4	51		168	218	110
VZXA-B-...-32-...-13.5-...-75-20-...	41	G11/4	11/4 NPT	Rc11/4	82.6		198	248	110
VZXA-B-...-40-...-9.3-...-75-20-...	41	G11/2	11/2 NPT	Rc11/2	82.6		216	270	120
VZXA-B-...-50-...-5.6-...-75-20-...	41	G2	2" NPT	Rc2	82.6		215	286	150

Type	L3	L4	L5	T1			T2	W1	≡C1
				S6	S7	S13			
VZXA-A-...-13-...-16-...-46-17-...	62	36.5	26.8	14	13.7	13.2	21.5	40	25
VZXA-A-...-20-...-16-...-75-20-...	94.4	53.1	41	16	14	14.5	24	40	32
VZXA-A-...-25-...-16-...-75-20-...	94.4	53.1	41	16	16.8	16.8	28	40	41
VZXA-B-...-13-...-30-...-46-17-...	62	36.5	26.8	14	13.7	13.2	21.5	40	25
VZXA-B-...-20-...-12.8-...-46-17-...	62	36.5	26.8	16	14	14.5	24	40	32
VZXA-B-...-20-...-30-...-75-20-...	94.4	53.1	41	16	14	14.5	24	40	32
VZXA-B-...-25-...-8.3-...-46-17-...	62	36.5	26.8	16	16.8	16.8	28	40	41
VZXA-B-...-25-...-23-...-75-20-...	94.4	53.1	41	16	16.8	16.8	28	40	41
VZXA-B-...-32-...-4.4-...-46-17-...	62	36.5	26.8	20	17.3	19.1	36	42	50
VZXA-B-...-32-...-13.5-...-75-20-...	94.4	53.1	41	20	17.3	19.1	36	42	50
VZXA-B-...-40-...-9.3-...-75-20-...	94.4	53.1	41	22	17.3	19.1	38	42	55
VZXA-B-...-50-...-5.6-...-75-20-...	94.4	53.1	41	24	17.6	23.4	43	40	65

# Angle seat valves VZXA with piston actuator

Technical data

## Ordering data

Key features:

- Control function closed via spring force, NC
- Without ATEX certification

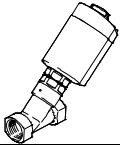
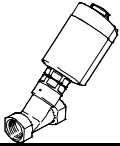
VZXA-A-..., flow direction above valve seat		Flow rate Kv [m <sup>3</sup> /h]	Medium pressure [bar]	Weight [g]	Part No.	Type
G thread to DIN ISO 228-1						
	DN13, 46 mm actuator	6.6	0 ... 16	1775	<b>8060513</b>	<b>VZXA-A-TS6-13-M2-V13T-16-K-46-17-PR-V4</b>
	DN20, 75 mm actuator	14.5		3155	<b>8060514</b>	<b>VZXA-A-TS6-20-M2-V13T-16-K-75-20-PR-V4</b>
	DN25, 75 mm actuator	21.5		3395	<b>8060515</b>	<b>VZXA-A-TS6-25-M2-V13T-16-K-75-20-PR-V4</b>
NPT thread to ANSI/ASME B 1.20.1						
	1/2", 46 mm actuator	6.6	0 ... 16	1775	<b>8060520</b>	<b>VZXA-A-TS7-1/2"-M2-V14T-16-K-46-17-PR-V4</b>
	3/4", 75 mm actuator	14.5		3155	<b>8060521</b>	<b>VZXA-A-TS7-3/4"-M2-V14T-16-K-75-20-PR-V4</b>
	1", 75 mm actuator	21.5		3395	<b>8060522</b>	<b>VZXA-A-TS7-1"-M2-V14T-16-K-75-20-PR-V4</b>

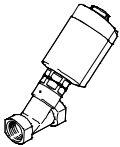
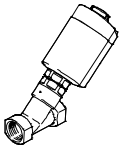
VZXA-B-..., flow direction below valve seat		Flow rate Kv [m <sup>3</sup> /h]	Medium pressure [bar]	Weight [g]	Part No.	Type	
G thread to DIN ISO 228-1							
	DN13, 46 mm actuator	6	0 ... 30	1830	<b>8060527</b>	<b>VZXA-B-TS6-13-M2-V13T-30-K-46-17-V4</b>	
	DN20, 46 mm actuator	13.3		0 ... 12.8	1910	<b>8060528</b>	<b>VZXA-B-TS6-20-M2-V13T-12.8-K-46-17-V4</b>
	DN20, 75 mm actuator	13.5		0 ... 30	3360	<b>8060529</b>	<b>VZXA-B-TS6-20-M2-V13T-30-K-75-20-V4</b>
	DN25, 46 mm actuator	20.3		0 ... 8.3	2150	<b>8060530</b>	<b>VZXA-B-TS6-25-M2-V13T-8.3-K-46-17-V4</b>
	DN25, 75 mm actuator	22.6		0 ... 23	3600	<b>8060531</b>	<b>VZXA-B-TS6-25-M2-V13T-23-K-75-20-V4</b>
	DN32, 46 mm actuator	27.9		0 ... 4.4	2480	<b>8060533</b>	<b>VZXA-B-TS6-32-M2-V13T-4.4-K-46-17-V4</b>
	DN32, 75 mm actuator	30.3		0 ... 13.5	3930	<b>8060534</b>	<b>VZXA-B-TS6-32-M2-V13T-13.5-K-75-20-V4</b>
	DN40, 75 mm actuator	41.4		0 ... 9.3	4610	<b>8060536</b>	<b>VZXA-B-TS6-40-M2-V13T-9.3-K-75-20-V4</b>
DN50, 75 mm actuator	50.1	0 ... 5.6	5430	<b>8060538</b>	<b>VZXA-B-TS6-50-M2-V13T-5.6-K-75-20-V4</b>		
NPT thread to ANSI/ASME B 1.20.1							
	1/2", 46 mm actuator	6	0 ... 30	1830	<b>8060541</b>	<b>VZXA-B-TS7-1/2"-M2-V14T-30-K-46-17-V4</b>	
	3/4", 46 mm actuator	13.3		0 ... 12.8	1910	<b>8060542</b>	<b>VZXA-B-TS7-3/4"-M2-V14T-12.8-K-46-17-V4</b>
	3/4", 75 mm actuator	13.5		0 ... 30	3360	<b>8060543</b>	<b>VZXA-B-TS7-3/4"-M2-V14T-30-K-75-20-V4</b>
	1", 46 mm actuator	20.3		0 ... 8.3	2150	<b>8060544</b>	<b>VZXA-B-TS7-1"-M2-V14T-8.3-K-46-17-V4</b>
	1", 75 mm actuator	22.6		0 ... 23	3600	<b>8060545</b>	<b>VZXA-B-TS7-1"-M2-V14T-23-K-75-20-V4</b>
	1 1/4", 46 mm actuator	27.9		0 ... 4.4	2480	<b>8060547</b>	<b>VZXA-B-TS7-1 1/4"-M2-V14T-4.4-K-46-17-V4</b>
	1 1/4", 75 mm actuator	30.3		0 ... 13.5	3930	<b>8060548</b>	<b>VZXA-B-TS7-1 1/4"-M2-V14T-13.5-K-75-20-V4</b>
	1 1/2", 75 mm actuator	41.4		0 ... 9.3	4610	<b>8060550</b>	<b>VZXA-B-TS7-1 1/2"-M2-V14T-9.3-K-75-20-V4</b>
2", 75 mm actuator	50.1	0 ... 5.6	5430	<b>8060552</b>	<b>VZXA-B-TS7-2"-M2-V14T-5.6-K-75-20-V4</b>		

# Angle seat valves VZXA, with diaphragm actuator

## Technical data

### Function

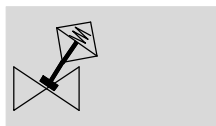

- Poppet valve with diaphragm actuator
- In-line installation  
1/2" ... 2", DN13 ... DN50
- Stroke  
26 mm



General technical data		DN25, 1"	DN32, 1 1/4"	DN40, 1 1/2"	DN50, 2"
In-line installation					
Actuator size	[mm]	90			
Flow rate Kv	VZXA-A-... [m³/h]	–	35.4	47.4	68.5
	VZXA-B-... [m³/h]	23.6	33.1	49	60.4
Design	Poppet valve with diaphragm actuator				
Actuation type	Pneumatic				
Type of mounting	In-line installation				
Mounting position	Any				
Valve function	2/2				
Pneumatic connection	Female thread G1/8				
Flow direction	Non-reversible				
Reset method	Mechanical spring				
Type of control	Externally controlled				
Position sensing	Via mechanical indicator				
Control of the medium	On/off operation				
Control function	VZXA-A-...	–	Closed via reduced spring force, NC		
	VZXA-B-...	Closed via spring force, NC			
Flow direction	VZXA-A-...	–	Over valve seat, for gaseous media		
	VZXA-B-...	Under valve seat, for gaseous and liquid media			

# Angle seat valves VZXA, with diaphragm actuator

Technical data

Operating and environmental conditions		
Operating pressure	[bar]	5 ... 7
Ambient temperature	[°C]	0 ... +60
Temperature of medium	[°C]	-10 ... +180
Storage temperature	[°C]	-10 ... +60
CE marking (see declaration of conformity) <sup>1)</sup>		To the EU Machinery Directive
Degree of protection		IP65
		IP67
		IP69K
Max. viscosity	[mm <sup>2</sup> /s]	600
Medium		Vapour
		Inert gases
		Filtered compressed air, grade of filtration 200 µm
	VZXA-B-... additionally	Mineral oil-based hydraulic oil
		Mineral oil
		Water
		Neutral fluids
Operating medium		Compressed air to ISO 8573-1:2010 [7:4:4]
Safety integrity level (SIL)		SIL 2
PFH		0.00000014
PFD		0.000595
Certificate issuing authority		TÜV 968/V 1039.00/18

1) Additional information [www.festo.com/sp](http://www.festo.com/sp) → Certificates.

ATEX <sup>1)</sup>		
ATEX category for gas		II 2G
Type of ignition protection for gas		c T6 ... T3 X
ATEX category for dust		II 2D
Type of ignition protection for dust		c T80°C ... T200 °C X
Explosion ambient temperature	[°C]	0°C ≤ Ta ≤ +60 °C

1) Selected types → [www.festo.com](http://www.festo.com)

# Angle seat valves VZXA, with diaphragm actuator

Technical data

Materials		Material number
Piston rod	High-alloy stainless steel	
Cover	Stainless steel casting	
Seals	NBR	
Stem seal	PTFE	
Seat seal	PTFE	
Actuator housing	Stainless steel casting	1.4408
Valve housing	Stainless steel casting	1.4409
		ASTM A351-CF3M
Note on materials	Contains paint-wetting impairment substances	
	RoHS-compliant	

Permissible operating pressure as a function of medium pressure for control function NC, VZXA-B-...		
	Min. operating pressure [bar]	Max. medium pressure [bar]
Actuator size	90 mm	
DN25, 1"	5	30
DN32, 1 1/4"	5	25
DN40, 1 1/2"	5	16
DN50, 2"	5	10

**Permissible operating pressure p<sub>2</sub> as a function of medium pressure p<sub>1</sub> for control function NC, VZXA-A-...**  
Diaphragm actuator size 90 mm

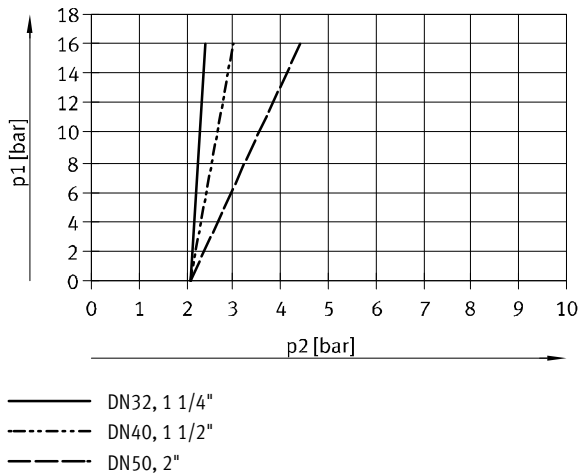

# Angle seat valves VZXA, with diaphragm actuator

Technical data

Dimensions Download CAD data → [www.festo.com](http://www.festo.com)  
 Size 90 mm

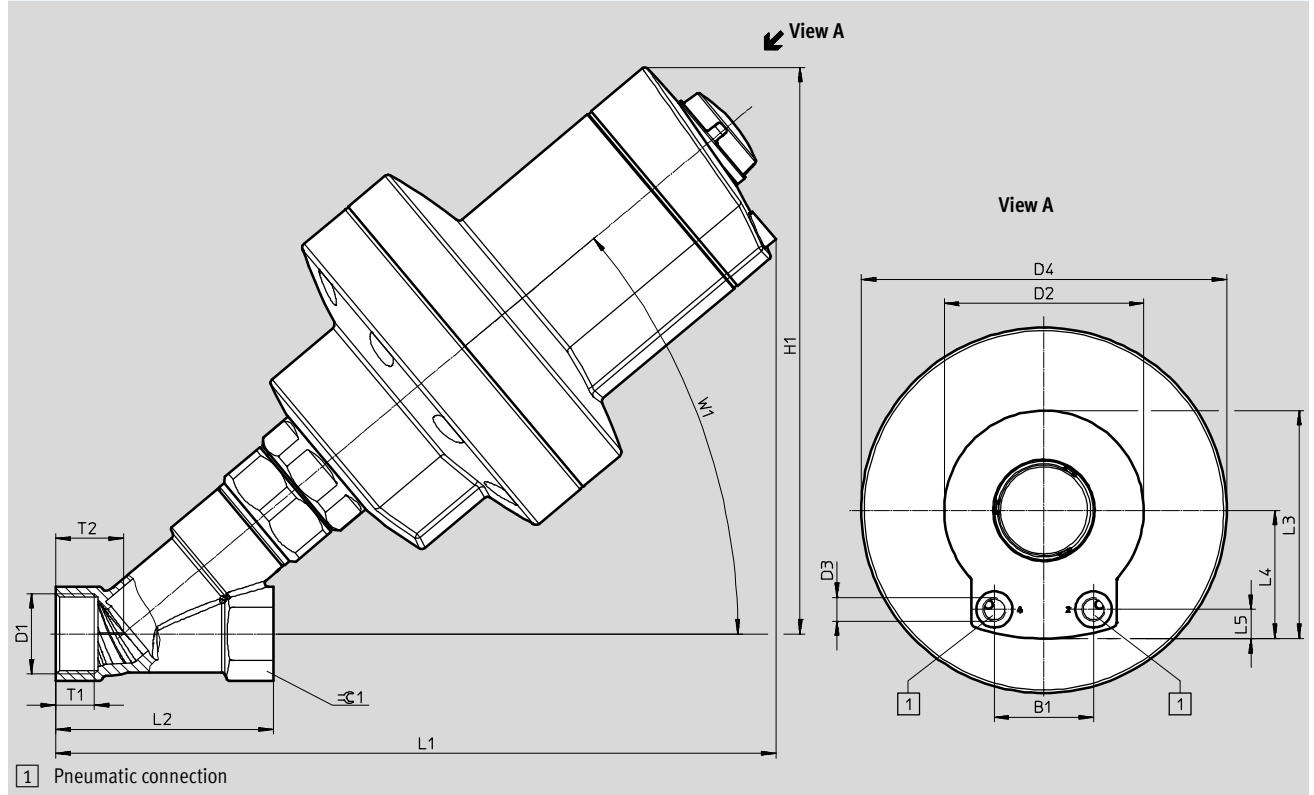

Type	B1	D1			D2 Ø	D3	D4 Ø	H1	L1	L2
		S6	S7	S13						
VZXA-A-...-32-...-16-...-PR-...	41	G1 1/4	1 1/4 NPT	Rc1 1/4	82.6	G1/8	151.3	245	300	110
VZXA-A-...-40-...-16-...-PR-...	41	G1 1/2	1 1/2 NPT	Rc1 1/2	82.6	G1/8	151.3	263	322	120
VZXA-A-...-50-...-16-...-PR-...	41	G2	2 NPT	Rc2	82.6	G1/8	151.3	260	340	150
VZXA-A-...-65-...-8-...-PR-...	41	G2 1/2	2 1/2 NPT	Rc2 1/2	82.6	G1/8	151.3	273	366	190
VZXA-B-...-25-...-30-...	41	G1	1 NPT	Rc1	82.6	G1/8	151.3	238	298	90
VZXA-B-...-32-...-25-...	41	G1 1/4	1 1/4 NPT	Rc1 1/4	82.6	G1/8	151.3	245	300	110
VZXA-B-...-40-...-16-...	41	G1 1/2	1 1/2 NPT	Rc1 1/2	82.6	G1/8	151.3	263	322	120
VZXA-B-...-50-...-10-...	41	G2	2 NPT	Rc2	82.6	G1/8	151.3	260	340	150

Type	L3	L4	L5	T1			T2	W1	≙C1
				S6	S7	S13			
VZXA-A-...-32-...-16-...-PR-...	94.4	53.1	12.1	20	17.3	19.1	36	42	50
VZXA-A-...-40-...-16-...-PR-...	94.4	53.1	12.1	22	17.3	19.1	38	42	55
VZXA-A-...-50-...-16-...-PR-...	94.4	53.1	12.1	24	17.6	23.4	43	40	65
VZXA-A-...-65-...-8-...-PR-...	94.4	53.1	12.1	27	24	27	53	40	85
VZXA-B-...-25-...-30-...	94.4	53.1	12.1	16	16.8	16.8	28	40	41
VZXA-B-...-32-...-25-...	94.4	53.1	12.1	20	17.3	19.1	36	42	50
VZXA-B-...-40-...-16-...	94.4	53.1	12.1	22	17.3	19.1	38	42	55
VZXA-B-...-50-...-10-...	94.4	53.1	12.1	24	17.6	23.4	43	40	65

# Angle seat valves VZXA, with diaphragm actuator

Technical data

## Ordering data

Key features:

- Control function closed via spring force, NC
- Without ATEX certification

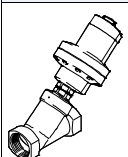
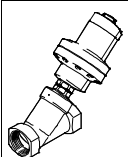
VZXA-A-..., flow direction above the valve seat		Flow rate Kv [m <sup>3</sup> /h]	Medium pressure [bar]	Weight [g]	Part No.	Type
G thread to DIN ISO 228-1						
	DN32, 90 mm actuator	35.4	0 ... 16	6595	<b>8060516</b>	<b>VZXA-A-TS6-32-M2-V13T-16-M-90-26-PR-V4</b>
	DN40, 90 mm actuator	47.4	0 ... 16	7275	<b>8060517</b>	<b>VZXA-A-TS6-40-M2-V13T-16-M-90-26-PR-V4</b>
	DN50, 90 mm actuator	68.5	0 ... 16	8095	<b>8060518</b>	<b>VZXA-A-TS6-50-M2-V13T-16-M-90-26-PR-V4</b>
NPT thread to ANSI/ASME B 1.20.1						
	1 1/4", 90 mm actuator	35.4	0 ... 16	6595	<b>8060523</b>	<b>VZXA-A-TS7-11/4"-M2-V14T-16-M-90-26-PR-V4</b>
	1 1/2", 90 mm actuator	47.4	0 ... 16	7275	<b>8060524</b>	<b>VZXA-A-TS7-11/2"-M2-V14T-16-M-90-26-PR-V4</b>
	2", 90 mm actuator	68.5	0 ... 16	8095	<b>8060525</b>	<b>VZXA-A-TS7-2"-M2-V14T-16-M-90-26-PR-V4</b>

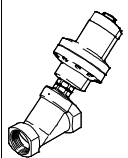
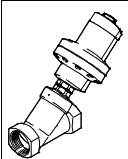
VZXA-B-..., flow direction below the valve seat		Flow rate Kv [m <sup>3</sup> /h]	Medium pressure [bar]	Weight [g]	Part No.	Type
G thread to DIN ISO 228-1						
	DN25, 90 mm actuator	23.6	0 ... 30	6780	<b>8060532</b>	<b>VZXA-B-TS6-25-M2-V13T-30-M-90-26-V4</b>
	DN32, 90 mm actuator	33.1	0 ... 25	7110	<b>8060535</b>	<b>VZXA-B-TS6-32-M2-V13T-25-M-90-26-V4</b>
	DN40, 90 mm actuator	49	0 ... 16	7790	<b>8060537</b>	<b>VZXA-B-TS6-40-M2-V13T-16-M-90-26-V4</b>
	DN50, 90 mm actuator	60.4	0 ... 10	8610	<b>8060539</b>	<b>VZXA-B-TS6-50-M2-V13T-10-M-90-26-V4</b>
NPT thread to ANSI/ASME B 1.20.1						
	1", 90 mm actuator	23.6	0 ... 30	6780	<b>8060546</b>	<b>VZXA-B-TS7-1"-M2-V14T-30-M-90-26-V4</b>
	1 1/4", 90 mm actuator	33.1	0 ... 25	7110	<b>8060549</b>	<b>VZXA-B-TS7-11/4"-M2-V14T-25-M-90-26-V4</b>
	1 1/2", 90 mm actuator	49	0 ... 16	7790	<b>8060551</b>	<b>VZXA-B-TS7-11/2"-M2-V14T-16-M-90-26-V4</b>
	2", 90 mm actuator	60.4	0 ... 10	8610	<b>8060553</b>	<b>VZXA-B-TS7-2"-M2-V14T-10-M-90-26-V4</b>

# Angle seat valves VZXA

Ordering data – Modular product system

Ordering table					
VZXA-...			Condi- tions	Code	Entry code
<b>M</b>	Module no.	<b>3539410</b>			
	Product type	VZXA		<b>VZXA</b>	VZXA
	Flow direction	Over valve seat, for gaseous media		<b>-A</b>	
		Under valve seat, for gaseous and liquid media		<b>-B</b>	
<b>O</b>	Control of the medium	On/off operation			
<b>M</b>	Line connection	Threaded collar		<b>-T</b>	-T
	Connection standard	DIN ISO 228-1		<b>S6</b>	
		ANSI/ASME B 1.20.1		<b>S7</b>	
		DIN 10226-2		<b>S13</b>	
	Connection size	DN13	<b>4</b>	<b>-13</b>	
		DN20	<b>4</b>	<b>-20</b>	
		DN25	<b>4</b>	<b>-25</b>	
		DN32	<b>4</b>	<b>-32</b>	
		DN40	<b>4</b>	<b>-40</b>	
		DN50	<b>4</b>	<b>-50</b>	
		1/2"	<b>1</b>	<b>-1/2"</b>	
		3/4"	<b>1</b>	<b>-3/4"</b>	
		1"	<b>1</b>	<b>-1"</b>	
		1 1/4"	<b>1</b>	<b>-1 1/4"</b>	
		1 1/2"	<b>1</b>	<b>-1 1/2"</b>	
		2"	<b>1</b>	<b>-2"</b>	
	Temperature of medium [°C]	-10 ... +180		<b>-M2</b>	
		-30 ... +200		<b>-M3</b>	
	Valve housing material	Stainless steel 1.4409	<b>2</b>	<b>-V13</b>	
		Stainless steel ASTM A351-CF3M	<b>3</b>	<b>-V14</b>	
	Seat seal material	PTFE		<b>T</b>	
		PTFE, modified	<b>5</b>	<b>TP</b>	

- 1** 1/2", 3/4", 1", 1 1/4", 1 1/2", 2" Not with connection standard S6, S13
- 2** V13 Not with imperial connection size
- 3** V14 Not with metric connection size
- 4** DN13, 20, 25, 32, 40, 50 Not with connection standard S7
- 5** TP Only with temperature of medium M3

**M** Mandatory data  
**O** Options

**Transfer order code**

VZXA - [ ] - [ ] - T [ ] - [ ] - [ ] - [ ] [ ]



# Angle seat valves VZXA

Ordering data – Modular product system

Ordering table						
VZXA-...				Condi- tions	Code	Entry code
↓ [M]	Medium pressure	[bar]	0 ... 4	[6]	-4	
		[bar]	0 ... 4.4	[6]	-4.4	
		[bar]	0 ... 4.8	[6]	-4.8	
		[bar]	0 ... 5.6	[6]	-5.6	
		[bar]	0 ... 5.8	[6]	-5.8	
		[bar]	0 ... 6	[6]	-6	
		[bar]	0 ... 6.2	[6]	-6.2	
		[bar]	0 ... 6.8	[7]	-6.8	
		[bar]	0 ... 7.5	[6]	-7.5	
		[bar]	0 ... 8	[7]	-8	
		[bar]	0 ... 8.3	[6]	-8.3	
		[bar]	0 ... 9.3	[6]	-9.3	
		[bar]	0 ... 10	[6]	-10	
		[bar]	0 ... 11.5	[6]	-11.5	
		[bar]	0 ... 12.2	[6]	-12.2	
		[bar]	0 ... 12.8	[6]	-12.8	
		[bar]	0 ... 13.5	[6]	-13.5	
		[bar]	0 ... 14.5	[6]	-14.5	
		[bar]	0 ... 15.5	[7]	-15.5	
		[bar]	0 ... 16		-16	
		[bar]	0 ... 23	[8], [6]	-23	
[bar]	0 ... 25	[8], [6]	-25			
[bar]	0 ... 30	[9], [6]	-30			
Actuator	Piston actuator				-K	
	Diaphragm actuator				-M	
Actuator size	[mm]	46	[14]		-46	
	[mm]	75	[14]		-75	
	[mm]	90	[15]		-90	
Stroke	[mm]	17	[10]		-17	
	[mm]	20	[11]		-20	
	[mm]	26	[12]		-26	
[O] Control function	Closed via spring force, NC					
	Double-acting		[14]		-D	
	Opened via spring force, NO				-S	
	Closed via reduced spring force, NC		[13]		-PR	
Position sensing	Via mechanical indicator					
[M] Actuator housing material	Stainless steel 1.4408				-V4	-V4
[O] EU certification	None					
	II 2GD				-EX4	

- [6] 4...6.2, 7.5, 8.3, 9.3, 11.5...14.5, 23...30 Not in conjunction with flow direction A
- [7] 6.8, 8, 15.5 Not in conjunction with flow direction B
- [8] 18, 20, 23, 25 Not with connection size DN50, 2", DN40, 1 1/2" or flow direction A
- [9] 30 Not with connection size DN50, 2", DN40, 1 1/2", DN32, 1 1/4" or flow direction A
- [10] Stroke 17 Only with drive K and size 46
- [11] Stroke 20 Only with drive K and size 75
- [12] Stroke 26 Only with drive M
- [13] Control function PR Must be in combination with flow direction A
- [14] Control function D, S Must be in combination with flow direction B
- [15] Size: 90 Not with drive K

- [M] Mandatory data
- [O] Options

**Transfer order code**

- [ ] - [ ] - [ ] - [ ] - [ ] - V4 - [ ]